



GENERAL GUIDELINE

Glass Embedding

01.05.2020 / VERSION 4 / SIKA SERVICES AG

TABLE OF CONTENTS

1	PURPOSE AND GENERAL INFORMATION	3
2	INTRODUCTION	3
3	DESIGN AND JOINT DIMENSIONING	4
4	PRODUCT STORAGE AND WORKING PLACE CONDITIONS	5
5	ADHESION BETWEEN COMPONENTS	5
6	PRODUCT PREPARATION	6
6.1	Curing speed	7
6.2	Removal of uncured adhesive	7
7	QUALITY ASSURANCE AND LOG BOOK DOCUMENTATION	7
8	INSTALLATION STEPS FOR SikaForce®-335 GG	8
9	REPAIR GLAZING	13

1 PURPOSE AND GENERAL INFORMATION

This document contains recommendations and hints for the application of SikaForce®-335 GG, a self-levelling polymer grout based on polyurethane resin, for the embedding of monolithic or laminated glass panes.

The information herein is offered for general guidance only. Since glass embedding is a critical application and conditions and safety requirements as well as substrates may vary greatly, the customer must grant the suitability of the construction in combination with the products for each specific project.

For detailed information about embedding products and surface pre-treatment agents please refer to the most recent Safety Data Sheets and Product Data Sheets.

2 INTRODUCTION

SikaForce®-335 GG is a self-levelling two-part polyurethane product suitable for embedding of monolithic or laminated glass panes into U-shaped support channels (made by e.g. anodized aluminum, polyester powder-coated aluminum, galvanized or stainless steel) for standard glass railing, frameless or postless guard rail and balcony glazing. This technique is also known as glass wall grouting.

SikaForce®-335 GG cures in place after the application and fixes the glass panes preventing stress concentration in the embedded parts, while ensuring uniform load distribution. It has proven its suitability for glass wall grouting applications in many projects under various climatic conditions.

This technology is also suitable for embedding of curved and irregular glass panes, allowing for accommodation of fabrication and installation tolerances.



Picture 1: Glass embedding in postless guard rail

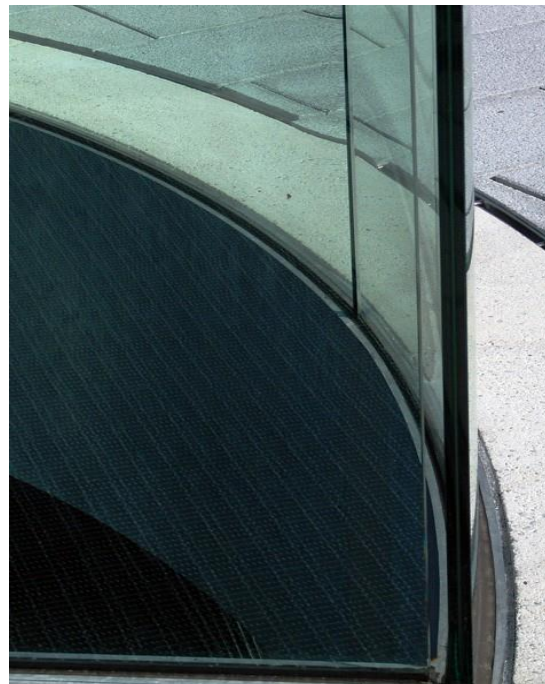

Picture 2: Embedding of curved glass

3 DESIGN AND JOINT DIMENSIONING

Joints must be properly dimensioned, as changes are no longer possible after neither construction nor adhesive application. Basis for the dimensioning of the necessary joint size are the rheological and curing properties of SikaForce®-335 GG product, the exposure of the building elements, their construction and size as well as expected loads (impact load, live load, wind, temperature, etc.).

- The thickness t of the embedding grout (clearance between the glass and the U-shaped support channel) must be at least 10 mm on both sides of the glass pane.
- The depth d of the embedding grout must be at least $d \geq H/10$ (H = total height of the glass pane) and not less than 75 mm.
- The final thickness t and depth d of the embedding grout must be defined by an engineer responsible for verifying the impact of details and embedded solution on glass and support channel, based on system configuration and requirements.

The mechanical properties of SikaForce®-335 GG depend on service temperature. Refer to Sika Additional Product Information "SikaForce®-335 GG for Glass Embedding" for comprehensive data.

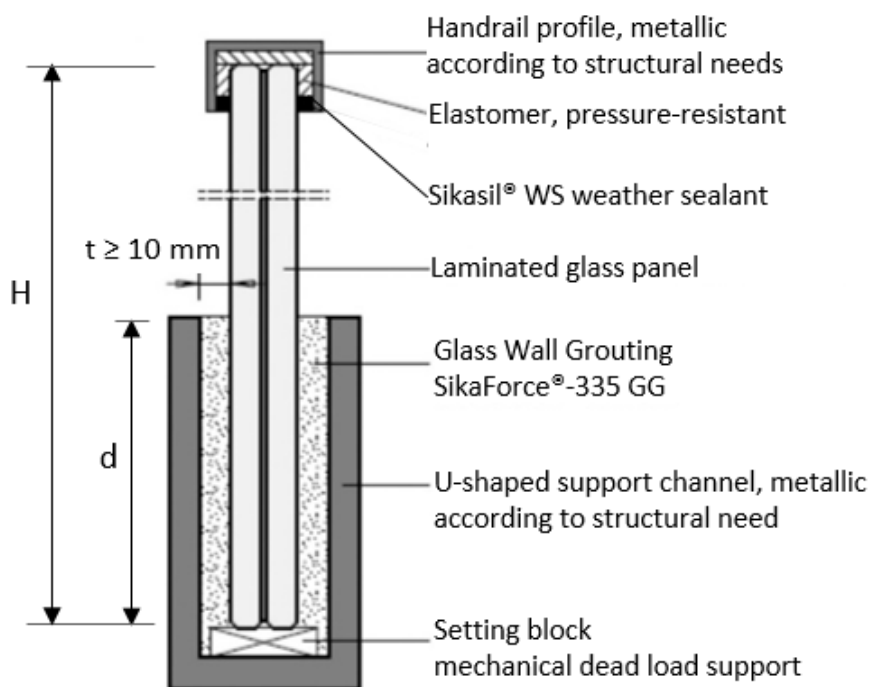

Picture 3: General detail drawing

SikaForce®-335 GG is suitable for indoor and outdoor applications.

For outdoor applications the embedding material must be protected from UV radiation and standing water by applying a bead of Sikasil® WS weather sealant on top. SikaForce®-335 GG must be cured at least 24 hours prior the sealant application.

For glass support, use of setting blocks made of SikaForce®-335 GG material used for the glass embedding is recommended. This can avoid stress concentration in the glass edge due to stiffness differences.

Regular expansion gaps can reduce stresses in the system that occur out of thermal movement of the different components.

The compatibility of other setting blocks, backer rods and other accessory materials in direct and indirect contact to SikaForce®-335 GG have to be approved by Sika in advance.

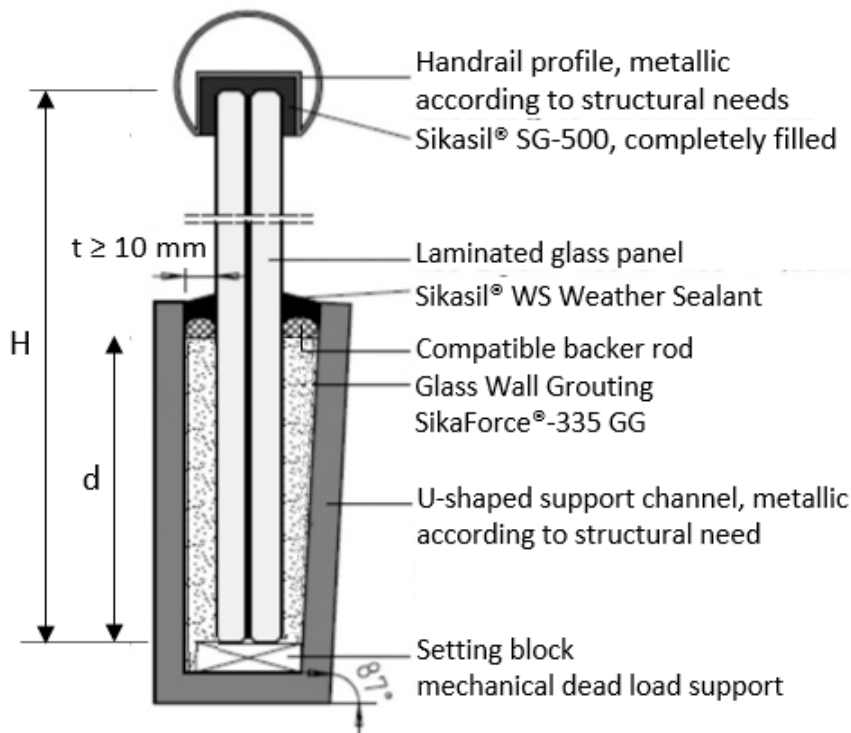

Picture 4: Feasible modifications of handrail, support frame and weather sealants as UV protection in outdoor applications

Consumption for SikaForce®-335 GG:

- Clearance $t = 10$ mm, filling-height 100 mm: approx. 2.5 litre per linear meter glass panel
- Clearance $t = 15$ mm, filling-height 150 mm: approx. 5.3 litre per linear meter glass panel

4 PRODUCT STORAGE AND WORKING PLACE CONDITIONS

Product containers have to be kept between 10 °C and 30 °C in a dry place. Do not expose to direct sunlight or frost. After opening of the packaging, the content must be protected against humidity. Minimum temperature during transportation is -20 °C for max. 7 days.

The working place should be as dust-free as possible. Ideal conditions are 23 °C and 50 % r.h.. Although these conditions are usually attainable only in laboratory, the applicator should try to meet these conditions as close as possible. SikaForce®-335 GG can be applied between 5 °C and 35 °C, the optimum application temperature of the product is between 15 °C and 30 °C. These limits apply to the temperature of the embedding grout, the substrates as well as the ambient temperature. The temperature of the substrates to be in contact with SikaForce®-335 GG must always be at least 3 °C higher than the dew point temperature of the air, to reduce condensation risks.

At low temperatures the viscosity of the product is higher and its application flow reduces.

SikaForce®-335 GG should be stored at least 24 hours prior to the application at a temperature of min. 15 °C.

5 ADHESION BETWEEN COMPONENTS

SikaForce®-335 GG is designed for glass wall grouting applications, where the grout is loaded only in compression (by contact to glass and U-shape support channel).

Apply a suitable release agent or bond breaker on all glass parts (including glass interlayers) that can get in contact with SikaForce®-335 GG, to prevent adhesion (see Chapter 8). This will also ease glass removal in case of accidental glass breakage.

If adhesion of SikaForce®-335 GG to glass is not prevented, the stress in the construction caused by thermal movements and external shear forces must be taken into consideration. An expert engineer must evaluate the impact of temperature variations and dilatations on components.

Whenever shear loads need to be transferred between glass panel and U-shaped support channel, the additional use of Sikasil® SG joints can be evaluated. For such cases, contact the Technical Department of Sika Industry.

6 PRODUCT PREPARATION

Both A and B component of SikaForce®-335 GG are supplied in metal containers.

For mixing A and B component use a suitable separate container. SikaForce®-335 GG shows an exothermic reaction, thus the temperature will increase while mixing; therefore, do not use plastic containers.

- Stir the base part (A component) thoroughly before use.
- Weight base (A component) and hardener (B component) to ensure the correct mixing ratio A:B by weight indicated on the Product data sheet (PDS).
- Add the hardener (B component) to the base (A component) in the given mixing ratio.
- Stir constantly (also along the bottom and side of the container) to obtain a homogenous mixture for approx. 3 min at 600 to 800 rpm, depending on temperature (the lower the temperature, the longer the mixing time). A butterfly or basket mixer is preferred but spiral mixer is also suitable.
- When a homogenous mixture is obtained, the material can be applied. The application must occur before reaching half of the pot life.

SikaForce®-335 GG can be applied manually or by pump in different ways, e.g. (Picture 5)

- After the glass panel is installed into the U-shaped support channel, the material can be poured from one side; the material must flow under the pane until it reaches the opposite side and all gaps and required joint depth are filled.
- After the glass panel is installed into the U-shaped support channel, the material can be poured from both sides; the material must flow to fill all gaps and up to the required joint depth.
- Before the glass panel is installed, the material can be poured into the U-shaped support channel. Subsequently, the glass panel can be installed dipping it into the grout material.

For further information about the application of SikaForce®-335 GG refer to Chapter 8.

Application method, system and details must be verified in a mock-up and by performance tests.

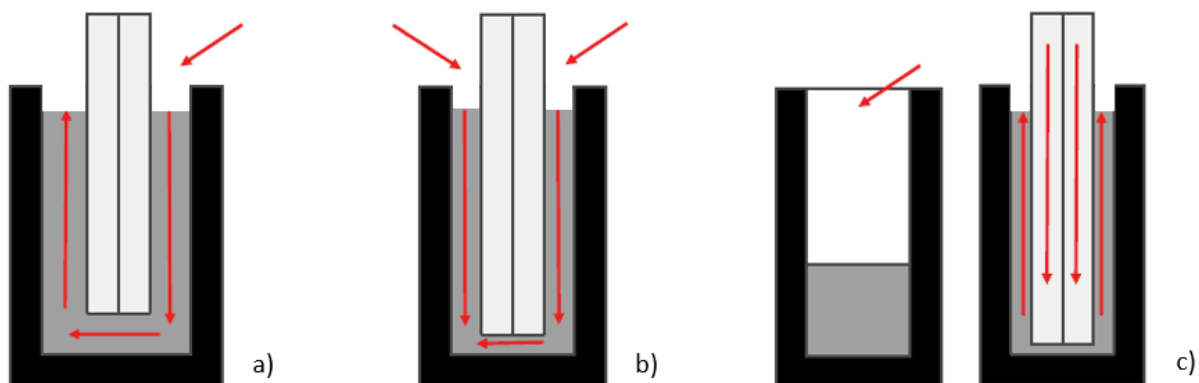

Picture 5: Application methods a) pouring the grout from one side, after glass installation b) pouring the grout from both sides, after glass installation c) pouring the grout before glass installation

6.1 Curing speed

The curing speed and process times of SikaForce®-335 GG depending on temperature.

Figure below shows the trend of Shore D development depending on temperature under laboratory conditions.

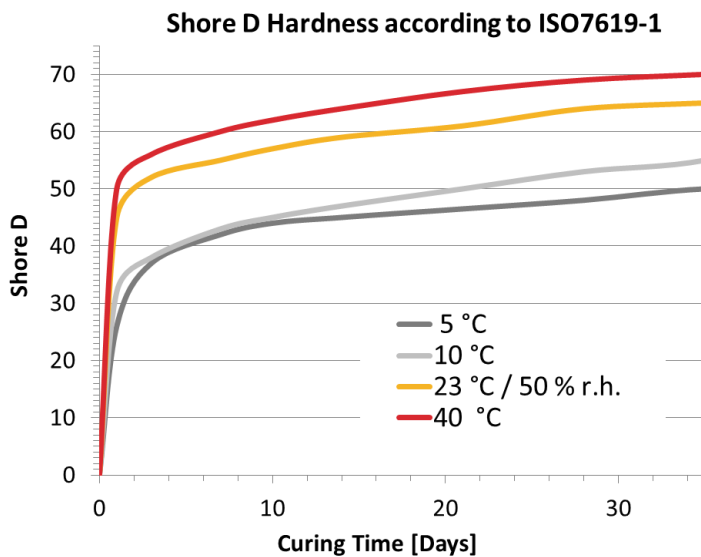

Picture 6: SikaForce®-335 GG - Shore D development at different temperatures.

6.2 Removal of uncured adhesive

Uncured SikaForce®-335 GG may be removed from tools and equipment with Sika® Remover-208. Once cured, the material can only be removed mechanically. Hands and exposed skin should be cleaned immediately using Sika® Cleaner-350H hand wipes or a suitable industrial hand cleaner and water. Spilt grout can be immediately removed with a dry cloth or paper and then with Sika® Cleaner-350H hand wipes. Do not use solvents.

7 QUALITY ASSURANCE AND LOG BOOK DOCUMENTATION

Perfect results require carrying out each processing step perfectly. Sika therefore recommends that the applicators install a strict quality control system. Quality control is the primary responsibility of the processor / applicator but Sika will assist customers in training of staff members.

Applicators must follow the instructions of this guideline closely and install an appropriate documentation system (log book).

Following data should be recorded:

- Date and time of application
- Ambient temperature, weather conditions
- Name of applicator
- Name, batch number and expiry date of grout products
- Name, batch number and expiry date of pre-treatments, if used
- Name of release agent or type of bond breaker, if used
- Kind of substrate

8 INSTALLATION STEPS FOR SikaForce®-335 GG

The following installation steps refer to method c) described in Section 6.

Always perform application trials and tests in a mock up before final application.

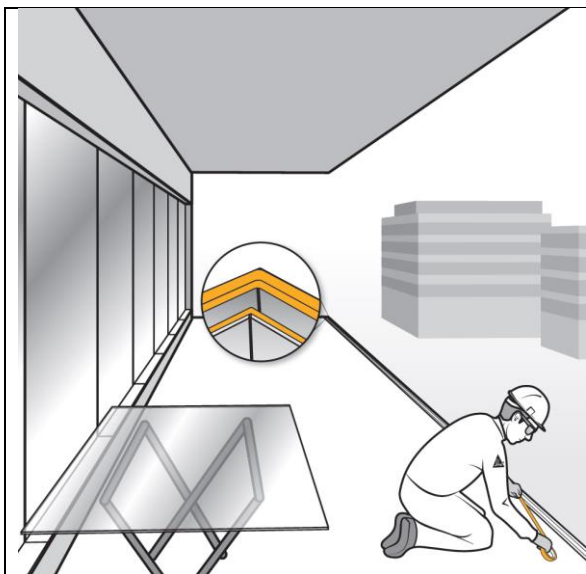

1) Workplace preparation

Proper workplace preparation is essential for every bonding project. Therefore prepare all materials to be used beforehand. Cover the surrounding area to prevent any contamination.

2) Cover the U-shaped support channel

After installation of the U-shaped support channel (take care that it is properly installed and in vertical position) and after workplace preparation, cover the edges of the support channel to keep them clean from any contamination during installation. For this purpose, the use of a paper masking tape is recommended.

Seal any openings in the U-shaped support channel with a tape to prevent uncontrolled outflow of the embedding grout.

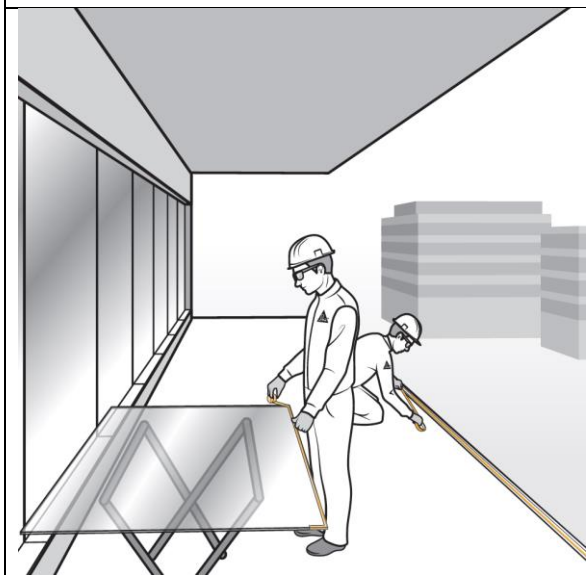

3) Prevent the adhesion to the glass interlayer

Mask the bottom edge and the vertical side parts of the laminated glass that will be embedded by using a suitable PE masking tape. This masking tape prevents the adhesion between SikaForce®-335 GG to the laminated glass interlayer.

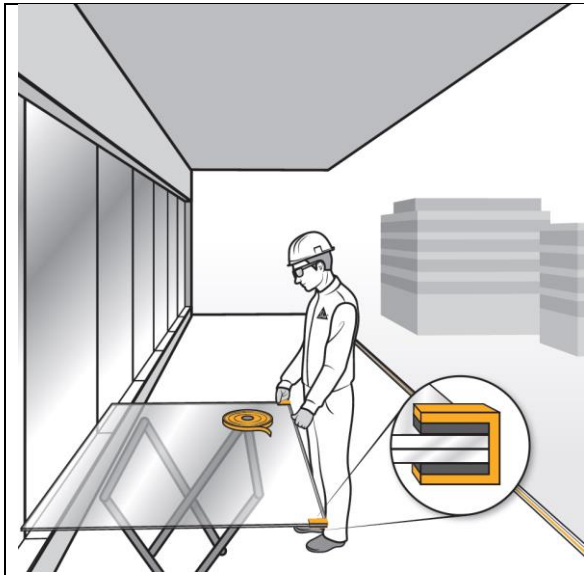

4) Apply Sika® Spacer Tape HD

Apply Sika® Spacer Tape HD at both ends of the glass pane, according to a U-shape.
The spacer tape is used to control the distance of the glass pane from the lateral walls of the U-shaped support channel.

The final thickness of the whole assembly (the Sika® Spacer Tape HD including the glass pane) should be approx. 5 mm thicker than the clearance of the support channel. Multiple layers of the spacer tape can be overlapped for this purpose.

5) Prevent the adhesion on the glass surfaces to embed

Apply a suitable release agent or bond breaker on all glass areas that will be in contact to the embedding material, to prevent any adhesion.

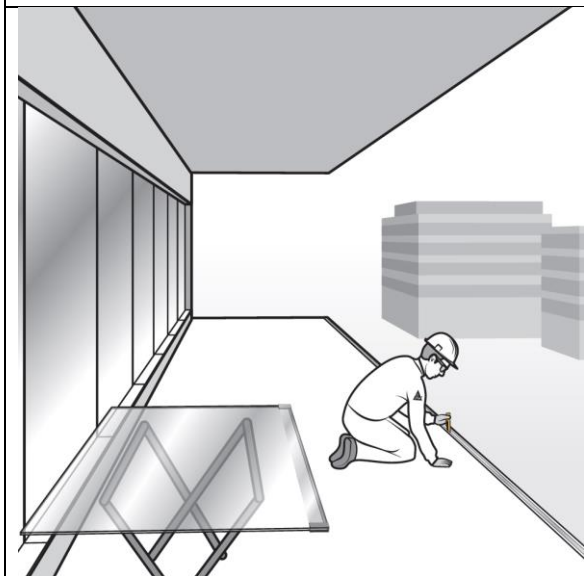

6) Install soft stoppers and setting blocks

Install soft stoppers into the U-shaped support channel to prevent SikaForce®-335 GG flowing uncontrolled along the whole length of the channel.

If use of setting blocks is required, install them into the U-shaped support channel.

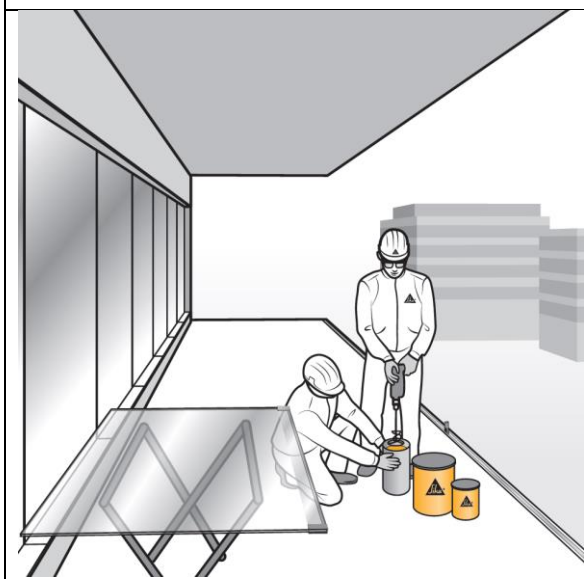

7) Preparation of SikaForce®-335 GG

- Stir the base (A component) thoroughly before use
- Add the hardener (B component) in the given mixing ratio
- Stir constantly (also along the bottom and side of the container) until a homogeneous mixture is obtained, approx. 3 min at 600 to 800 rpm, depending on temperature. The lower the temperature, the longer the mixing time.
- A butterfly or basket mixer is preferred.

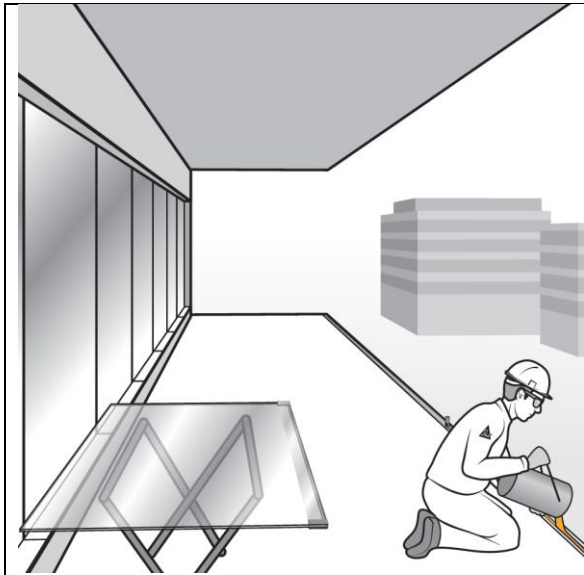

8) Application of SikaForce®-335 GG

Pour SikaForce®-335 GG evenly into the U-shaped support channel. Check the height of the adhesive (see Picture 5c).

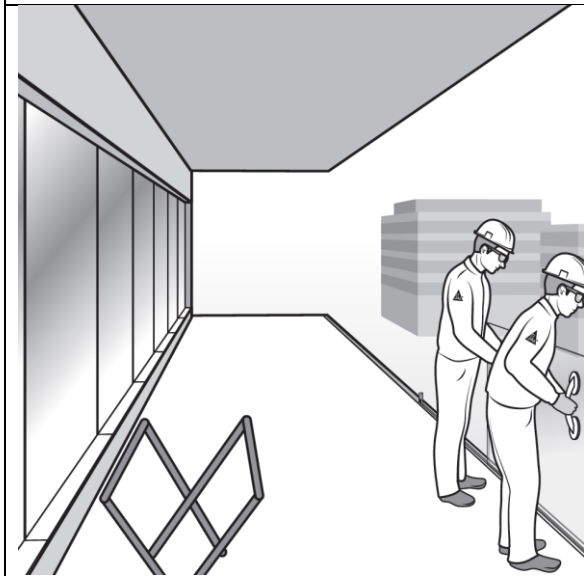

9) Glass installation

Install the prepared glass pane. Push it to the bottom of the support channel. Check height, horizontal and vertical position of the glass pane.

Always apply the grout and the glass before reaching half of the pot life.

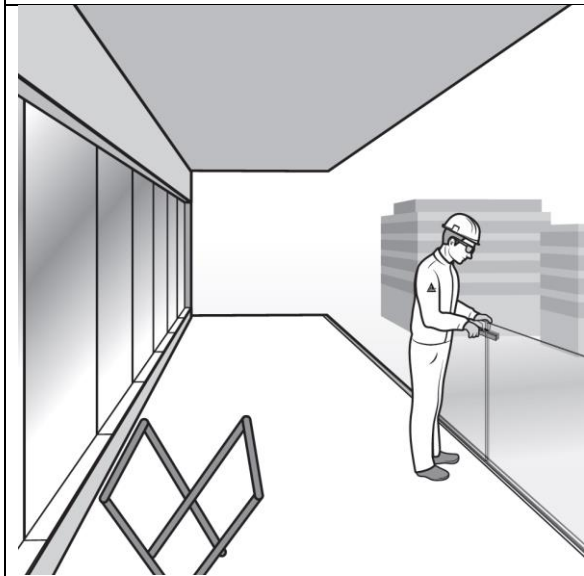

10) Installation of the adjacent panels

Apply SikaForce®-335 GG and install the adjacent glass pane according to the same method.

Fix the glass pane to the previous one by applying a clamp at the top edges. This will ensure a proper alignment of the panes.

Remove the masking tapes from glass and U-shaped support.

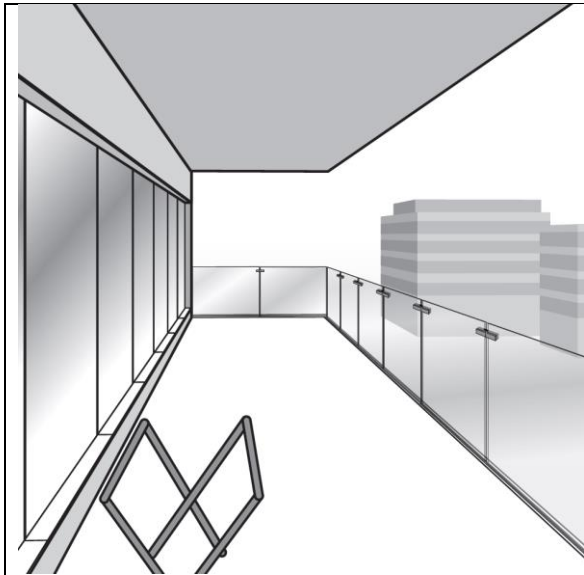

11) Curing of SikaForce®-335 GG

Repeat the procedure until all glass panes are installed.
Let SikaForce®-335 GG cure for at least 24 hours.

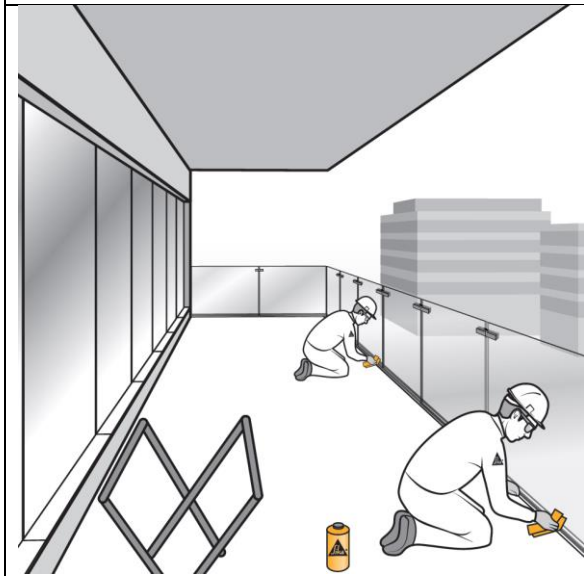

12) Application of the weather sealant

In order to protect the PU grout against UV radiation and standing water, in outdoor applications a bead of Sikasil® WS must be applied on top of the fully cured grout, earliest after 24 hours.

Clean the faces to seal with Sika® Cleaner P.

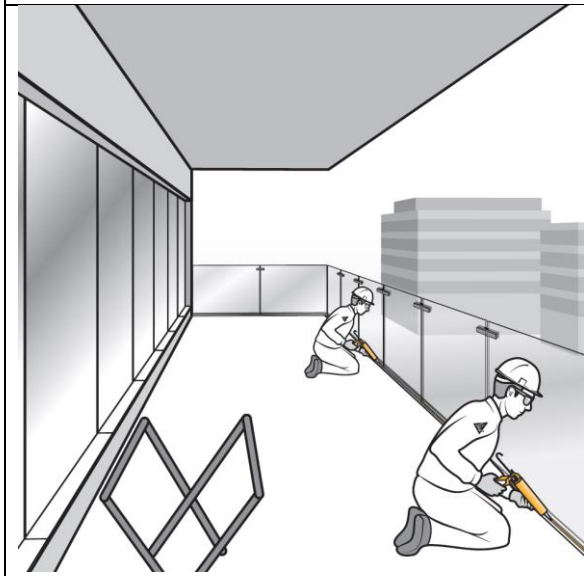

13) Apply the weather sealant.

Sikasil® WS products are recommended for this application.
Masking with paper masking tape prior to the weather seal application is recommended.

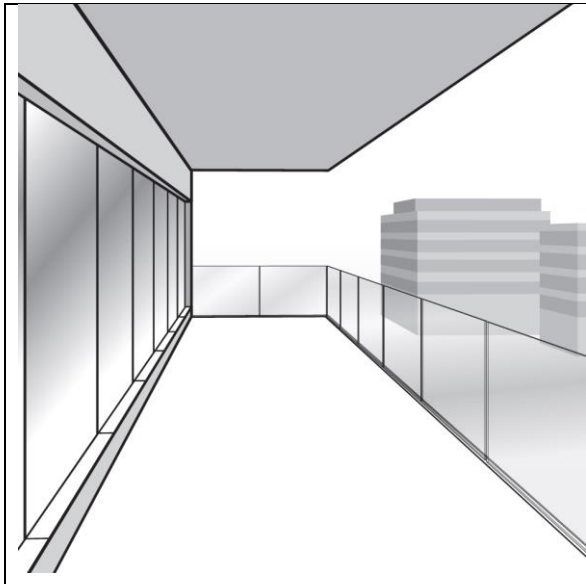

14) Install the handrails when specified.

9 REPAIR GLAZING

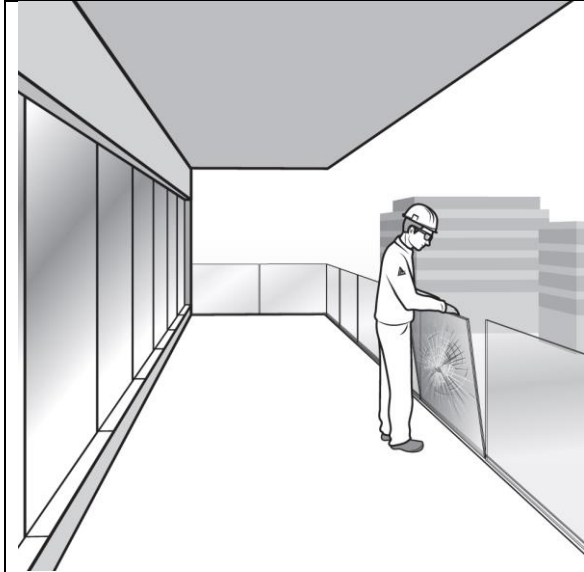

1) Remove the broken glass

If a glass unit must be replaced, at first the broken glass needs to be removed. Smash the glass with a hammer to expose the safety glass foil at the very bottom, close to the embedding material. Cut the safety glass foil with a knife and remove the glass unit.



2) Remove the embedding material and the glass remains

A demolition hammer can be used to remove the embedding material and the glass remains.

Start with the first approx. 30 cm from the edge and work out the glass and the embedding material. Then use a crowbar to remove finally all the remains of glass and embedding material.

Clean the support frame properly from dust and remains of glass and embedding material.

3) Installation of the new glass

Follow the application procedure described in Chapter 8.

LEGAL NOTE

The information, and, in particular, the recommendations relating to the application and end-use of Sika products, are given in good faith based on Sika's current knowledge and experience of the products when properly stored, handled and applied under normal conditions in accordance with Sika's recommendations. In practice, the differences in materials, substrates and actual site conditions are such that no warranty in respect of merchantability or of fitness for a particular purpose, nor any liability arising out of any legal relationship whatsoever, can be inferred either from this information, or from any written recommendations, or from any other advice offered. The user of the product must test the products suitability for the intended application and purpose. Sika reserves the right to change the properties of its products. The proprietary rights of third parties must be observed. All orders are accepted subject to our current terms of sale and delivery. Users must always refer to the most recent issue of the local Product Data Sheet for the product concerned, copies of which will be supplied on request.

Version given by

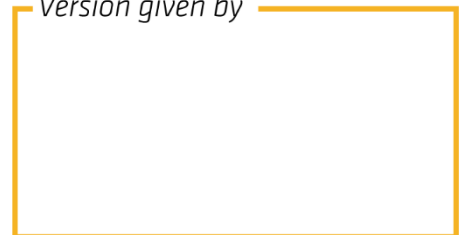

© 2019 Sika Services AG