



Sikafloor® Marine

SOUND TEST REPORT

Sikafloor® Marine FLF Type 26

VEM X Steel + Litosilo Steel + SikaForce® 7752 FRW

PERFORMED BY DELTA Acoustics

BUILDING TRUST





DELTA Test Report



Sound insulation properties of Sikafloor® Marine flooring constructions

Sikafloor® Marine Visco FLF Type 26

Performed for Sika Services AG

DANAK 100/2385

Project no.: 118-21873

Page 1 of 37

14 June 2018

**DELTA – a part of
FORCE Technology**
Venlighedsvej 4
2970 Hørsholm
Denmark

Tel. +45 72 19 40 00
Fax +45 72 19 40 01
www.delta.dk
VAT No. 55117314

Sound insulation properties of Sikafloor® Marine flooring constructions
Sikafloor® Marine Visco FLF Type 26

Journal no.	Project no.	Our ref.	Date of test
DANAK 100/2385	118-21873	LOD/ilc	12 March 2018

Client

Sika Services AG
Tüffenwies 16
CH 8048 Zürich
Switzerland

Client ref.

Carsten Brutus Jørgensen

Summary

The airborne sound insulation and the impact sound insulation are measured according to the ISO and ASTM standards.

Furthermore, the structure-borne sound properties are measured according to ASTM standards and measuring procedure applied by DELTA Acoustics.

Remark

The test results apply only to the objects tested.

DELTA – a part of FORCE Technology, 14 June 2018



Leif Ødegaard
Acoustics

Contents

1. Introduction	4
2. Test facilities and methods	4
2.1 Standards	4
2.2 Test facilities	5
2.3 Measurement methods	6
2.3.1 ISO 10140:2010	6
2.3.1.1 Airborne sound insulation	7
2.3.1.2 Impact sound insulation	7
2.4 Measurement of structure-borne sound properties	8
2.4.1 Effect of treatment	8
2.4.2 Radiation efficiency	10
2.5 ASTM E2963-16	11
2.5.1 Transmission loss	11
2.5.2 Acceptance	12
2.5.3 Radiation efficiency	13
2.5.4 Absorption	13
2.5.5 Damping for constrained damped constructions	14
2.5.6 Damping for floating floor constructions	15
2.5.7 Effect of treatment	15
3. Measurement uncertainty	16
4. General measurement results	17
4.1 Measurements according to ISO standards and structure-borne sound measuring method	17
4.2 Measurements according to ASTM E2963-16	17
5. Results for Sikafloor® Marine Visco-FLF Type 26	18
5.1 Results according to ISO standards	19
5.2 Structure-borne noise properties	20
5.3 Results according to ASTM E2963-16	22
5.3.1 Effectiveness	24
6. Comments	26
7. References	27
8. Instrumentation	28
Graph Sheets 1-8	29

1. Introduction

This test report describes the results and procedures for measurements of acoustical and structural vibration properties for marine flooring systems.

2. Test facilities and methods

2.1 Standards

The airborne sound insulation, the impact sound insulation and the structure-borne sound insulation are measured according to the following standards and methods:

- 1) ISO 10140:2015: “Acoustics – Laboratory measurement of sound insulation of building elements” - Part 1,
- 2) ISO 10140:2010: “Acoustics – Laboratory measurement of sound insulation of building elements” -part 2, 4 and 5.
- 3) ISO 717:2013: “Acoustics – Rating of sound insulation in buildings and of building elements” - Part 1 and 2.
- 4) “Procedure for measurement of acoustical and structural properties of maine flooring systems”, DELTA Technical Note, TC-100853.
- 5) ASTM E2963-16: “Standard Test Method for Laboratory Measurement of Acoustical Effectiveness of Ship Noise Treatments – Laboratory Measurement of Acoustical Effectiveness for Marine Bulkhead and Deck Treatments”.
- 6) ASTM E756-5(2010): “Standard Test Method for Measuring Vibration-Damping Properties of Materials”.

2.2 Test facilities

The measurements are carried out in two reverberant rooms at the Technical University of Denmark, 2800 Kgs. Lyngby.

The rooms are built on two separate foundations made of concrete with a wall thickness of 30 cm. Between the source room and the receiving room there is an opening of 2.99 m x 3.37 m, i.e. in the ceiling of the source room and in the floor of the receiving room, see Figure 1.

The volume of the source room and receiving room is 243 m³ and 230 m³, respectively.

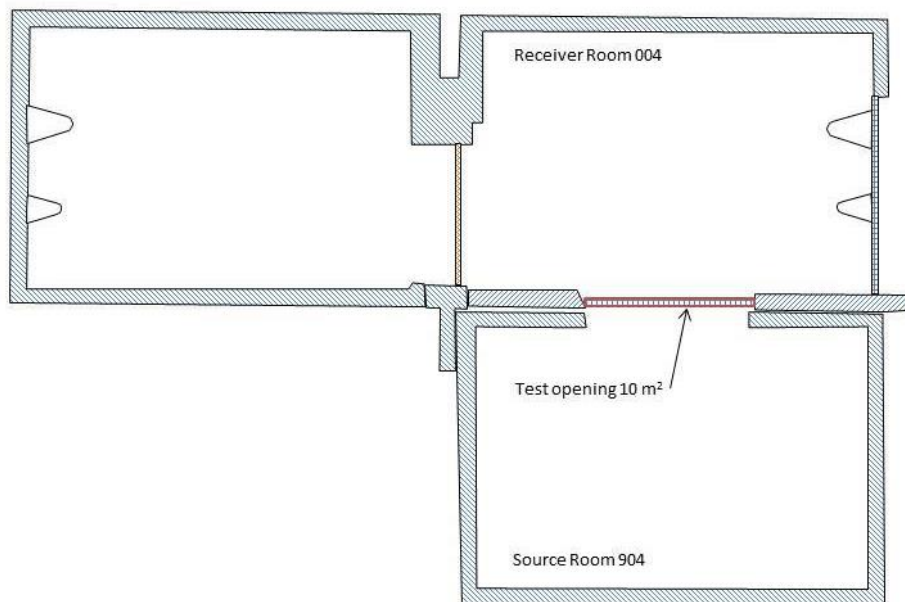

Figure 1

A sketch of the measurement rooms at the Technical University of Denmark.

Excitation of the deck with airborne noise and impact noise is carried out with loudspeakers and a tapping machine as stated in ISO 10140:2010.

Excitation of the deck with structure-borne noise is performed by means of a vibration exciter coupled to a steel plate, which is mounted perpendicularly and below the steel deck positioned in the opening. By means of this arrangement a reverberant vibrational field is established both in the steel plate coupled to the exciter and the steel deck simulating the real conditions occurring in a ship structure. A sketch of the arrangement is shown in Figure 2.

The steel deck is stiffened by 4 flat bars spaced 740 mm in the longitudinal direction. The steel deck is elastically mounted in the test opening. The gap between the opening and steel deck is sealed with mineral wool and tape. The remaining visible part of the supporting steel beams towards receiving room are covered by a heavy rubber matt to avoid flanking noise radiation.

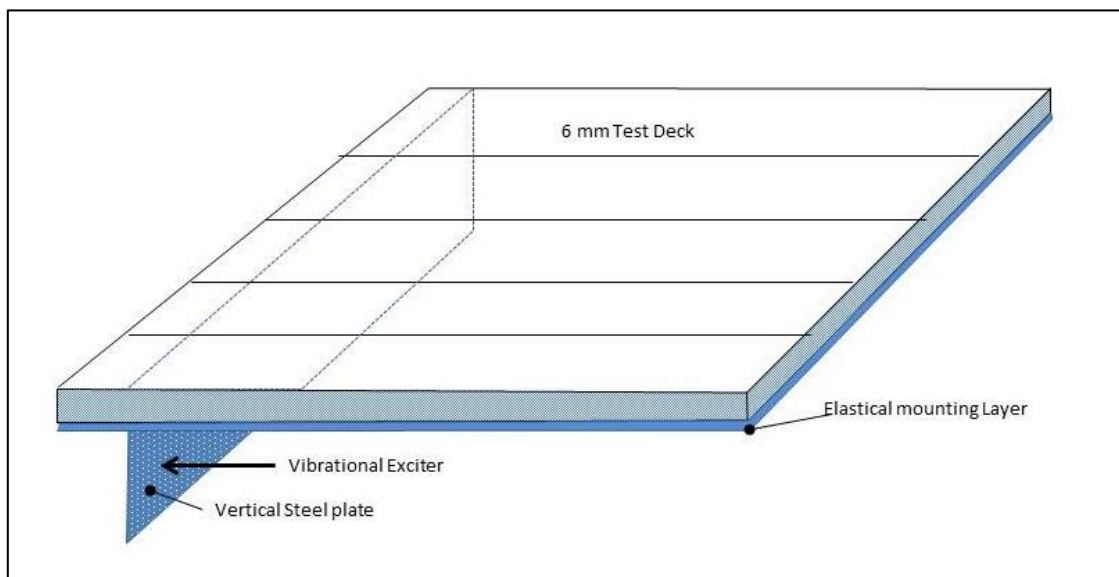

Figure 2
A sketch of the arrangement consisting of the 6 mm test deck, the elastic mounting of the deck and the 6 mm steel plate coupled to the test deck. The arrow indicates the position of the electro-dynamic exciter.

2.3 Measurement methods

2.3.1 ISO 10140:2010

During the airborne and structure-borne sound measurements the excitation is performed by means of broadband pink noise in the frequency range 20-10000 Hz.

The response, i.e. the sound pressure level in the receiving room for the airborne and impact sound insulation measurements or the velocity level on the floor for the structure-borne sound measurements, will be measured in one-third octave filter bands with centre frequencies from 50 Hz to 5000 Hz.

Measurements in the one-third octave filter bands of 50 Hz, 63 Hz and 80 Hz are not required according to ISO 10140:2010. However, based on experience from previous measurements on ships, it seems reasonable to include these frequency ranges.

Due to the volume of the test rooms, some additional uncertainty occurs for the measurements in the one-third octave filter bands of 50 Hz, 63 Hz and 80 Hz. In Section 2 the measurement results from these frequency bands are therefore presented for information only.

All relevant instruments in the test setup are calibrated before and during the testing period for every construction.

2.3.1.1 Airborne sound insulation

The airborne sound insulation is normally specified by the sound reduction index, R , as defined according to the ISO 10140 series:

$$R = L_1 - L_2 + 10 \log(S / A) \text{ dB}$$

where

L_1 = average sound pressure level in the source room

L_2 = average sound pressure level in the receiving room

S = area of the test floor, which was 10 m^2

A = equivalent absorption area in m^2 in the receiving room

From the measured values of R , the weighted sound reduction index, R_w (formerly: airborne sound insulation index I_a) is calculated. The calculations follow the procedure as stated in ISO 717-1:2013.

2.3.1.2 Impact sound insulation

The normalized impact sound pressure level, L_n , is defined as the impact sound pressure level, L_i , increased by a correction term given in decibels and being ten times the common logarithm of the ratio between the measured equivalent absorption area A of the receiving room and the reference equivalent absorption area A_0 , i.e.

$$L_n = L_i + 10 \log (A/A_0) \text{ dB} \quad (1)$$

where

$$A_0 = 10 \text{ m}^2$$

For each measurement series the weighted normalised impact sound pressure level $L_{n,w}$ (formerly: impact sound index I_i) is calculated as stated in ISO 717-2:2013.

2.4 Measurement of structure-borne sound properties

No international ISO standard exists for measurement of structure-borne sound insulation properties for marine floors and bulkheads. Consequently, this test will be carried out by means of a method previously performed by DELTA and used for similar constructions.

Vibrational power is supplied to the steel deck by means of the arrangement described in Figure 2. The supply of constant vibrational power is monitored during the measurement period by means of a force transducer mounted between the vertical steel plate and the vibration exciter. Further, the acceleration level at the input position on the vertical steel plate is measured for monitoring purpose.

The response is measured as the velocity level, L_v in dB re 10^{-9} m/s in minimum 24 different positions on the test surface, on the steel deck below the test construction and on the floor.

Measurement positions are selected pseudo-randomly on the test structure.

2.4.1 Effect of treatment

From the average value of the velocity level measured on the test surface the transmission loss TL_v and insertion loss IL_v and IL_p will be calculated. Further, the radiation efficiency will be calculated.

The measured transmission loss TL_v in dB for the constructions describes the difference between the velocity level on the steel deck after installation of the floor construction and the velocity level measured on top of the floor covering. Thus, the transmission loss expresses the reduction in the velocity level from the steel deck to the floor covering

The transmission loss TL_v for a structure during test is calculated using the following formula:

$$TL_v = L_{v,above} - L_{v,below}$$

where

$L_{v,above}$ = time and space average vibration velocity on top of the test construction in the receiver room, dB re: 1 nm/s

$L_{v,below}$ = time and space average vibration velocity below of the test construction in the source room, dB re: 1 nm/s.

The measured insertion loss IL_v in dB describes the difference between the velocity level measured on the bare steel deck before installation of the floor construction and the velocity level measured on top of the applied floor construction. The insertion loss IL_v describes the improvement of the vibration level on the floor achieved by using the floor covering.

The insertion loss, IL_v , for a structure during test is calculated using the following formula:

$$IL_v = L_{v,above} - L_{v,ref}$$

where

$L_{v,above}$ = time and space average vibration velocity on top of the test construction in the receiver room, dB re: 1 nm/s

$L_{v,ref}$ = time and space average vibration velocity of the bare steel deck before application of the test construction room, dB re: 1 nm/s.

The measured insertion loss, IL_p , in dB regarding radiated structure-borne sound to the room describes the difference between the measured radiated sound pressure level in the receiving room before installation of the floor covering and the measured radiated sound pressure level after applying the floor covering. The insertion loss, IL_p , thus expresses the improvement of the sound level in the room above the deck achieved by using the floor covering.

The insertion loss, IL_p , for a structure-borne radiated noise is calculated using the following formula:

$$IL_p = L_{p,test\ construction} - L_{p,ref}$$

where

$L_{p,test\ construction}$ = averaged sound pressure level in dB re 20 μ Pa in the receiving room with the test construction mounted on the steel reference deck.

$L_{p,ref}$ = averaged sound pressure level in dB re 20 μ Pa in the receiving room with the bare steel deck without the test construction mounted.

2.4.2 Radiation efficiency

The radiation index describes the ability of a vibrating floor to radiate sound. A high radiation index combined with a high velocity level on the floor covering causes high noise levels in the rooms above the deck covering.

The radiation efficiency is normally expressed as a logarithmic quantity named the radiation index, $10\log\sigma$. If the radiation index is determined from sound power measurements in a reverberant room, this can be calculated using the following formula:

$$10\log\sigma = L_w - L_v - 10\log(S/1\text{m}^2) + 34 \text{ dB}$$

or based on the averaged sound pressure level in the receiving room:

$$10\log\sigma = L_p - L_v + 10\log V - 10\log T - 10\log(S/1\text{m}^2) + 10 \log(1 + F \lambda/8V) + 20 \text{ dB}$$

where

L_w = averaged sound power in dB re 1pW

L_p = averaged sound pressure level in dB re. $20\mu\text{Pa}$ in the receiving room

L_v = averaged velocity level in dB re 1mm/s measured on the surface of the covering floor

S = area of the test floor, which is 10 m^2

V = volume in m^3 of the receiving room, which is 230 m^3

T = reverberation time in seconds

F = total area in m^2 of the surface in the receiving room, which is 300 m^2

λ = wavelength in m of the centre frequency of the one-third octave filter band in question.

$10\log(1 + F \lambda/8V)$ is normally called the Waterhouse correction

Due to a very high damping in some of the tested constructions, the radiated structure-borne noise from the floor coverings can be influenced by flanking noise contribution from the test rooms. This phenomenon takes place in the high frequency range above 2 kHz.

Consequently, the radiated sound pressure level in the receiving room can optionally be determined using intensity measuring technique. The radiation index might in these situations be calculated based on the measured sound power level and not on basis of the measured sound pressure level.

2.5 ASTM E2963-16

The full scale test of marine flooring constructions is expensive and is normally done for a number of different flooring constructions mounted successive upon the reference steel deck. This allows comparing the different flooring constructions directly. However, this means that the reference deck must not be removed from the test opening during the measuring series. This is necessary in order not to introduce differences due to the mounting in the test facilities.

Measurements of transmission loss and acceptance will be performed simultaneously with airborne noise excitation in the source room. Measurements of sound absorption are done in connection with the transmission loss measurements. Measurements of transmission loss are performed in accordance with ASTM E90-09.

Primarily the damping properties for the constrained damped test constructions will be determination of the loss factor using the test beam method e.g. as described in ASTM E756-5(2010).

The loss factor cannot be evaluated for floating floors, as the loss factor does not describe the vibration damping properties for such floor systems.

All calculations are performed for each one-third octave band frequency.

2.5.1 Transmission loss

According to ASTM E90-09 the transmission loss for a structure during test is calculated using following formula:

$$TL = L_1 - L_2 + 10 \log[S/A_2]$$

where

TL = transmission loss of the structure, dB

L₁ = time and space average sound pressure level in the source room,
dB re 20 μPa

L₂ = time and space average sound pressure level in the receiver room,
dB re 20 μPa

S = surface area of the test structure, m²

A₂ = equivalent absorption area in m² in the receiving room

2.5.2 Acceptance

Measurements of acceptance are performed by generating an acoustic signal in the source room and measuring the generated sound pressure level in the source room as well as the surface vibration of the test structure.

The acceptance of a structure during test is defined here as assuming a reverberant receiver room:

$$L_{\Lambda} = L_1 - L_v$$

where

L_{Λ} = acceptance of the structure, dB re 20 μ Pa/10nm/s

L_1 = time and space average sound pressure level in the source room, dB re 20 μ Pa, and

L_v = time and space average surface vibration velocity level on the test structure, dB re 10 nm/s.

For each measurement of vibration, the measured acceleration level will be converted to velocity using the equation:

$$L_v = L_a - 20 * \text{Log}(2 * \pi * f) + 60$$

where

L_v = vibration velocity level in dB re 10 nm/s

L_a = vibration acceleration level in dB re 10 μ m/s²

f = one-third-octave band centre frequency.

The space and time averaged vibration velocity level will be calculated in each one-third-octave band.

2.5.3 Radiation efficiency

Measurements of radiation efficiency will be performed separately with structure-borne noise excitation with the exciter system as described in Section 2.2.

Measurements of radiation efficiency are performed by energizing the vibration exciter and measuring the responding vibration of the test structure as well as the sound pressure level in the receiving room.

The calculation of radiation efficiency for a structure under test uses the equation:

$$L_{\sigma} = L_2 - L_v - 10 * \text{Log}[4 * S / A_2] + 13.7$$

where

L_{σ} = radiation efficiency of the structure, dB re 20 μ Pa/10 nm/s

L_2 = time and space average sound pressure level in the receiver room, dB re 20 μ Pa

L_v = time and space average vibration velocity level in the receiver room, dB re 10 nm/s

S = surface area of the test structure, m^2

A_2 = equivalent absorption area in m^2 in the receiving room.

The same values as stated in Section 2.4.2 will be obtained except for the Waterhouse correction used in Section 2.4.2.

2.5.4 Absorption

The change in absorption will be evaluated based on the measurement of the reverberation time in the receiving room (treated side of construction) and the calculated absorption area. An absorption coefficient α will be calculated based on the reverberation time with the bare steel deck installed and the reverberation time with the floor construction applied.

The calculation of treatment absorption is performed using the following equation:

$$\alpha = (A_{\text{Treat}} - A_{\text{No treat}}) / S_{\text{Treat}}$$

where

A_{Treat} = equivalent sound absorption area after the treatment has been applied (m^2)

A_{NoTreat} = equivalent sound absorption area in the same room prior to application of the treatment (m^2)

S_{Treat} = surface area of the test structure (m^2).

2.5.5 Damping for constrained damped constructions

Primarily, the damping properties for the constrained damped test constructions will be determined as the loss factor using the test beam method e.g. as described in ASTM E756-5(2010). Based on the measured values a regression analysis is performed in order to get estimated one-third octave values for the loss factor.

Alternatively, the damping properties of the constrained damped test constructions will also be evaluated by measuring the total loss factor using the guide lines described in ISO 10848-1:2006: “Acoustics -- Laboratory measurement of the flanking transmission of airborne and impact sound between adjoining rooms -- Part 1: Frame document - Section 7.3 Measurement of structural reverberation time”.

The excitation method is vibrator excitation with the exciter mounted as described in Section 2. The impulse response is measured e.g. with the MLS (Maximum Length Sequence) or vibration sweep techniques. The integrated impulse response method is used with backward integration of the squared impulse response as defined in ISO 3382: “Measurement of the reverberation time of rooms with reference to other acoustical parameters”.

The relation between the total loss factor and the structural reverberation time is as follows:

$$\eta_{\text{total}} = 2.2 / (f \cdot T_s)$$

where

f = frequency in Hz

T_s = structural reverberation time in seconds.

This method allows a practical approach for applying damping properties for the test construction without removing the construction from the test opening.

Based on the measured values a regression analysis is performed in order to get estimated one-third octave values for the loss factor.

2.5.6 Damping for floating floor constructions

The loss factor for floating floor constructions cannot be evaluated, as the loss factor does not describe the vibration damping properties for such systems.

An estimate for the structure-borne noise reduction for floating floor constructions might be estimated based on the insertion loss, IL_v , determined as described in section 2.4.1. This is not a part of ASTM E2963-15.

2.5.7 Effect of treatment

Transmission Loss

This equation is used to calculate the effect of the treatment on transmission loss:

$$\Delta TL = TL_{\text{Treat}} - TL_{\text{Non-Treat}}$$

where

ΔTL = change in transmission loss due to the application of the treatment, dB

TL_{Treat} = transmission loss calculated for the test structure with the treatment, dB

$TL_{\text{Non-Treat}}$ = transmission loss calculated for the test structure without the treatment, dB.

Acceptance

This equation is used to calculate the effect of the treatment on acceptance:

$$\Delta L_{\Lambda} = L_{\Lambda, \text{Treat}} - L_{\Lambda, \text{Non-Treat}}$$

where

ΔL_{Λ} = change in acceptance due to the application of the treatment, dB

$L_{\Lambda, \text{Treat}}$ = acceptance calculated for the test structure with the treatment, dB

$L_{\Lambda, \text{Non-Treat}}$ = acceptance calculated for the test structure without the treatment, dB.

Radiation efficiency

This equation is used to calculate the effect of the treatment on radiation efficiency:

$$\Delta L_{\sigma} = L_{\sigma, \text{Non-Treat}} - L_{\sigma, \text{Treat}}$$

where

ΔL_{σ} = change in radiation efficiency due to the application of the treatment, dB

$L_{\sigma, \text{Treat}}$ = radiation efficiency calculated for the test structure with the treatment, dB

$L_{\sigma, \text{Non-Treat}}$ = radiation efficiency calculated for the test structure without the treatment, dB.

Loss factor

The change in damping loss for constrained damped constructions will be computed using the equation:

$$\Delta \eta = \eta_{\text{treated}} - \eta_{\text{non-treated}}$$

where

η = damping loss factor. This will be a function of frequency.

3. Measurement uncertainty

According to EN ISO 12999-1:2014 precision of laboratory measurements expressed as the expanded uncertainty U given as a two-sided 95 % confidence level ($k = 1.96$) is as follows:

Value	U (k =1.96, two-sided)
R_w	± 2.4 dB
$L_{n,w}$	± 3.0 dB

The standard deviations of the structural and acceptance vibration measurements are in the range from 2.5 dB to 4.5 dB depending on frequency and position on the test deck.

The standard deviations of the structural sound measurements are in the range from 0.1 dB to 2.5 dB depending on frequency.

4. General measurement results

4.1 Measurements according to ISO standards and structure-borne sound measuring method

Results of the measurements of the airborne sound insulation, the impact sound insulation and the structure-borne sound insulation for the investigated floor constructions are for each tested construction.

The results are expressed as one-third octave values in the frequency ranges 50 Hz to 5000 Hz and, when appropriate, as a single-number quantity calculated according to the ISO standards.

The results of the sound pressure measurement in the frequency range below 100 Hz are given for the information only, as the dimensions of the two reverberant rooms are too small for measuring precisely in this frequency range.

Furthermore, the results of the measurements on the bare steel deck are indicated with black on each diagram for the airborne sound and the impact sound measurements. The difference between the curves for the test deck and the curves for the reference steel deck thus indicates the improvement in the sound reduction and the impact sound insulation caused by the applied floor construction.

4.2 Measurements according to ASTM E2963-16

The results of the measurements of the airborne sound insulation, acceptance and the radiation efficiency for the investigated floor constructions are for each tested construction.

The results are expressed as one-third octave values in the frequency ranges 50 Hz to 5000 Hz and, when appropriate, as a single-number quantity calculated according to the ISO standards.

The results of the sound pressure measurement in the frequency range below 100 Hz are given for the information only, as the dimensions of the two reverberant rooms are too small for measuring precisely in this frequency range.

The acoustical effectiveness regarding transmission loss, acceptance, radiation efficiency, and absorption and loss factor (when relevant) is calculated based on reference measurements on a bare steel deck for each deck construction.

5. Results for Sikafloor® Marine Visco-FLF Type 26

The floor is a combined constrained damped and floating floor construction. The constrained damped construction is type Sikafloor® Marine Visco EM 4 consisting of approximately 1.5 mm viscoelastic damping layer type VEM X. The density of compound is 1,300 kg/m³. On top of the damping layer 1.5 mm steel plates with coverage of 90 % is applied.

The floating floor consists of 50 mm mineral wool Type SeaRox SL 436, with a density of 140 kg/m³. The top layer consists of 2 steel plates (tiles 1000x2000 mm), thickness 3 mm and 1.5 mm respectively, which are glued with approximately 0.6 mm layer of SikaForce® 7752 FRW L 60. The total surface mass is approximately 58.2 kg/m² for the total construction. The total building height is 58 mm.

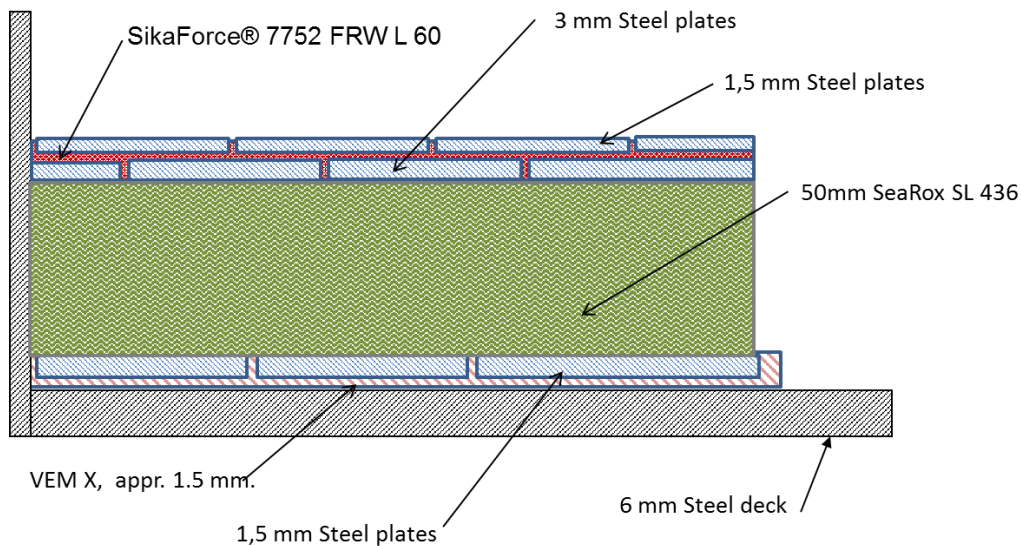

Figure 3
Principle sketch of the test construction.

Layer	Density kg/m ³	Thickness mm
Viscoelastic layer VEM X	1,300	1.5
Constrained layer 1.5 mm steel plates	7860	1.5
Mineral wool SeaRox SL 436	140	50
Top layer 1,5 mm and 3 mm steel tiled glued with 0.6 mm SikaForce® 7752 FRW L 60	6667	5

Table 1
Product data for the tested construction.

The main results are given in the Graph sheets.

5.1 Results according to ISO standards

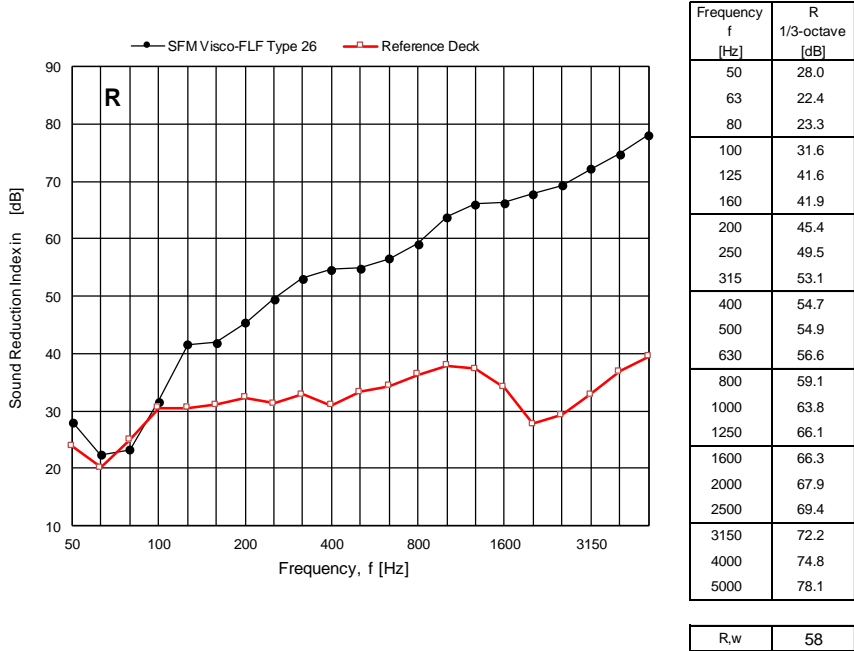

Figure 4
Measured sound reduction index R for the Sikafloor® Marine Visco FLF Type 26 expressed in dB per one-third octave frequency bands. For comparison the results of the measurements on the bare steel deck are also shown.

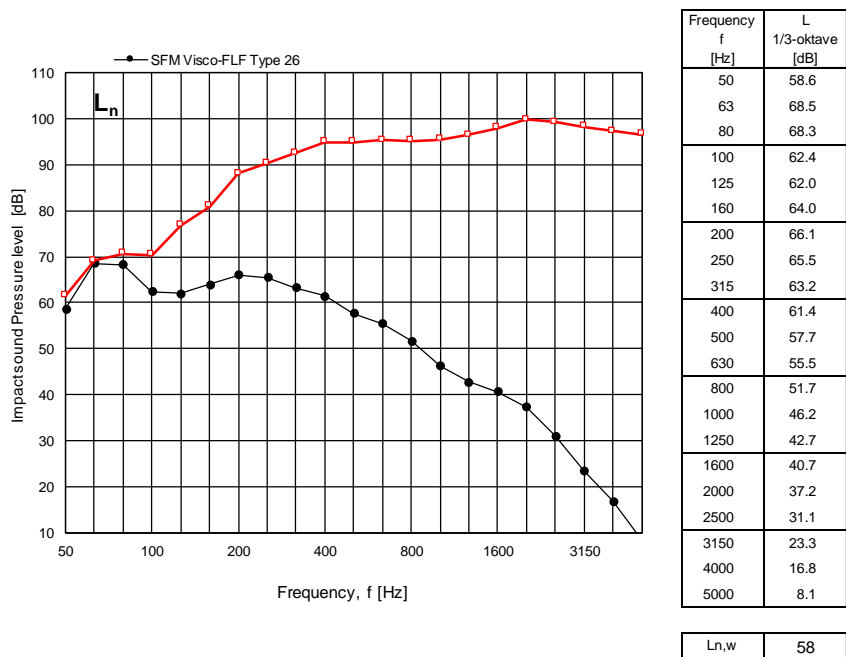

Figure 5
Measured normalized impact sound pressure level L_n for Sikafloor® Marine Visco FLF Type 26 expressed in dB re 20 μ Pa per one-third octave frequency band. For comparison the results of the measurements on the bare steel deck are also shown.

5.2 Structure-borne noise properties

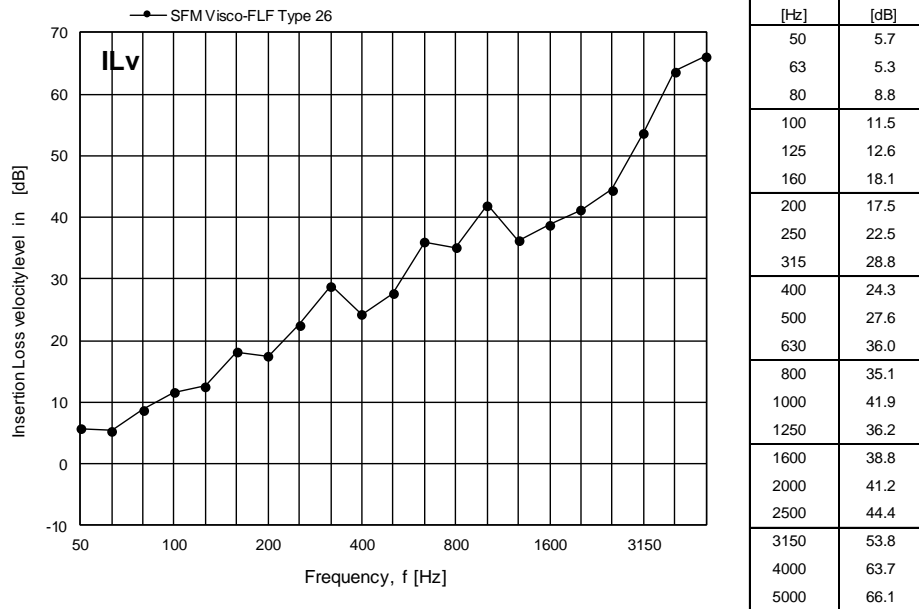

Figure 6
Measured Insertion Loss IL_v for Sikafloor® Marine Visco FLF Type 26 expressed in dB per one-third octave frequency band. The insertion loss IL_v refers to the mean velocity level in dB re 10-9 m/s on top of the floor covering.

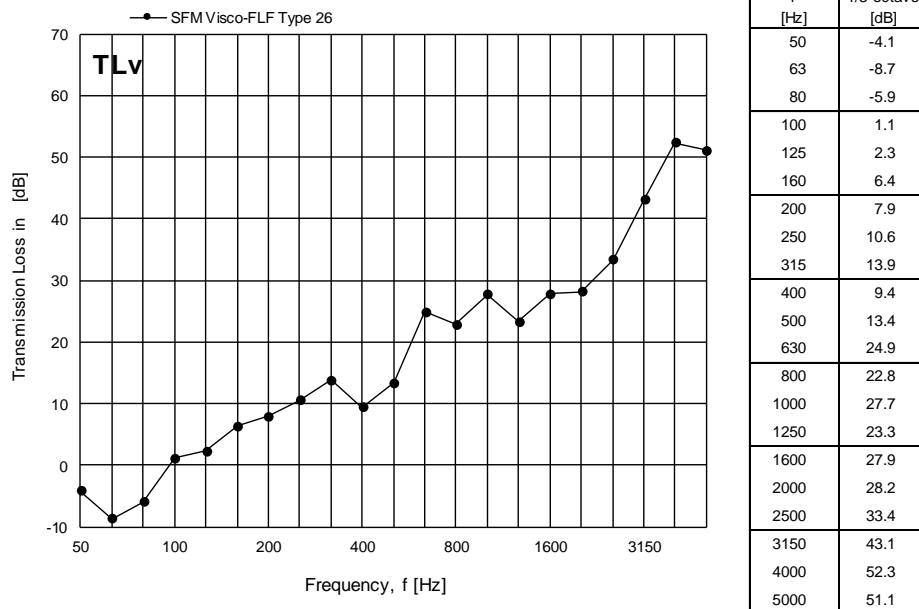

Figure 7
Measured Transmission Loss TL_v for Sikafloor® Marine Visco FLF Type 26 expressed in dB per one-third octave frequency band. The insertion loss TL_v refers to the mean velocity level in dB re 10-9 m/s on top of the floor covering.

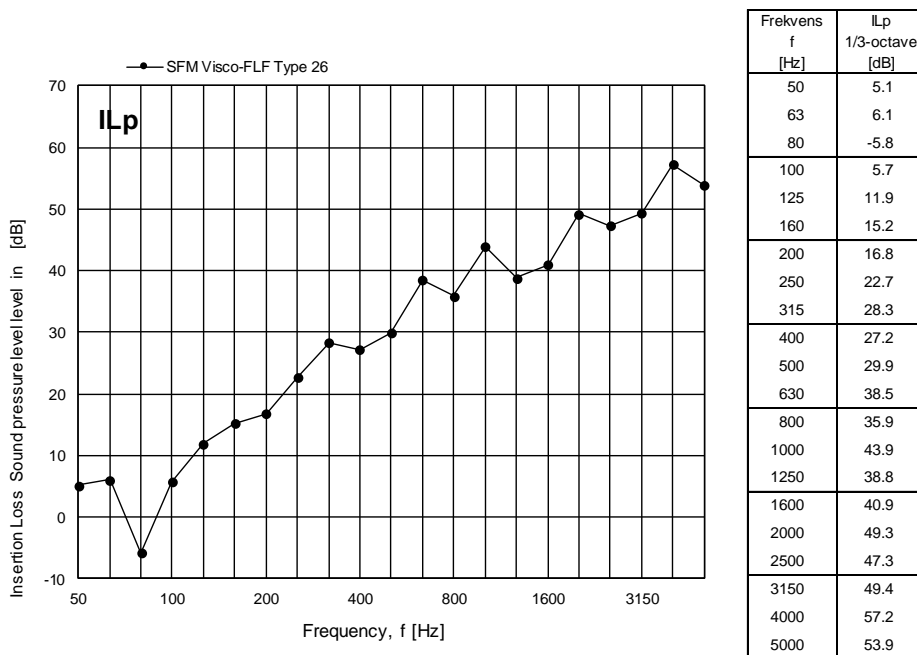

Figure 8
 Measured insertion loss IL_p for Sikafloor® Marine Visco FLF Type 26 expressed in dB per one-third octave frequency band. The insertion loss IL_p refers to the radiated mean sound pressure level in dB re 20 μ Pa in the receiving room above the floor.

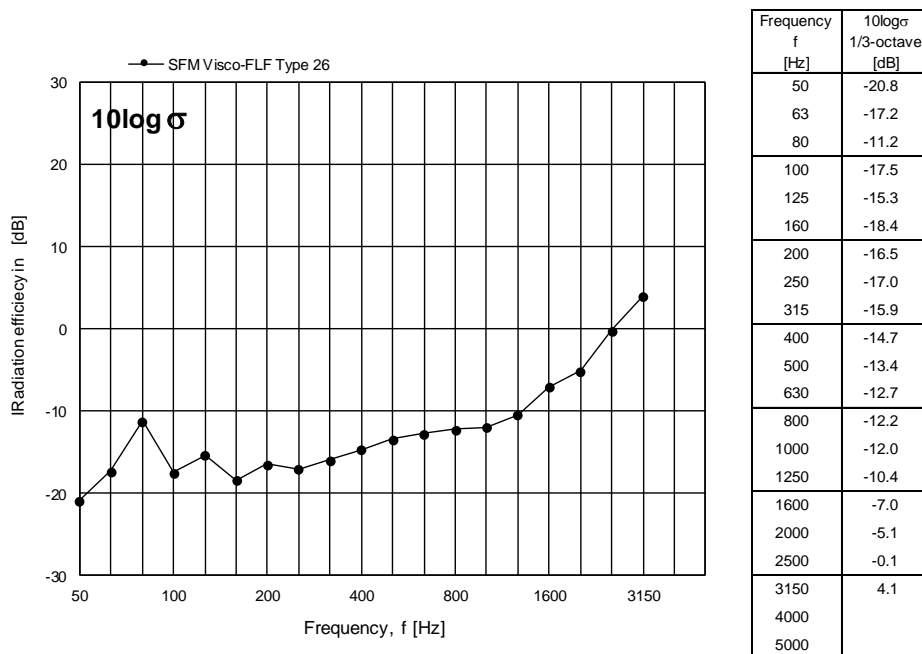

Figure 9
 Measured radiation index $10 \log \sigma$ for Sikafloor® Marine Visco FLF Type 26 expressed in dB per one-third octave frequency band.

5.3 Results according to ASTM E2963-16

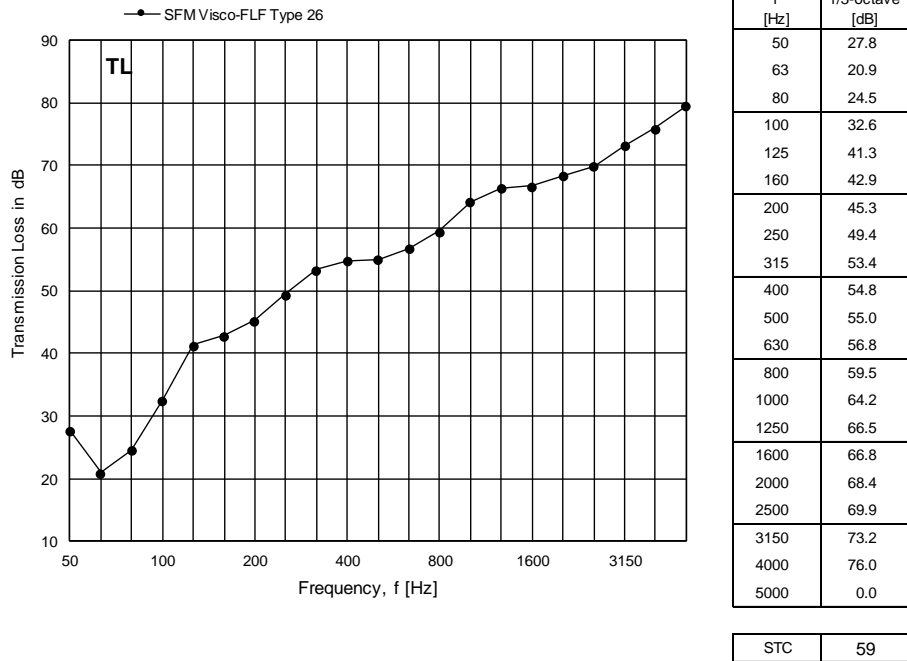

Figure 10
Measured transmission loss TL for Sikafloor® Marine Visco FLF Type 26 expressed in dB per one-third octave frequency band.

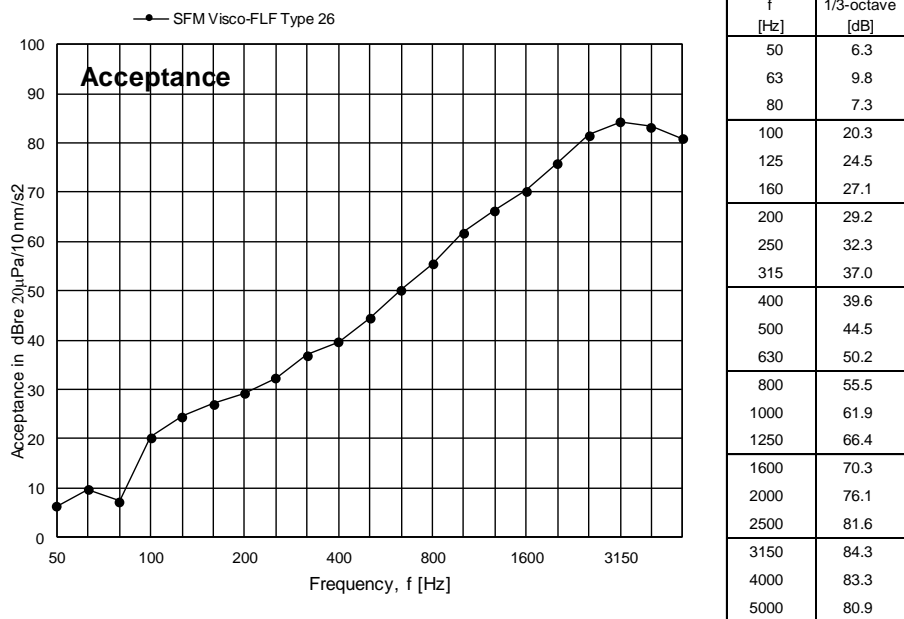

Figure 11
Measured acceptance L_A for Sikafloor® Marine Visco FLF Type 26 expressed in dB per one-third octave frequency band.

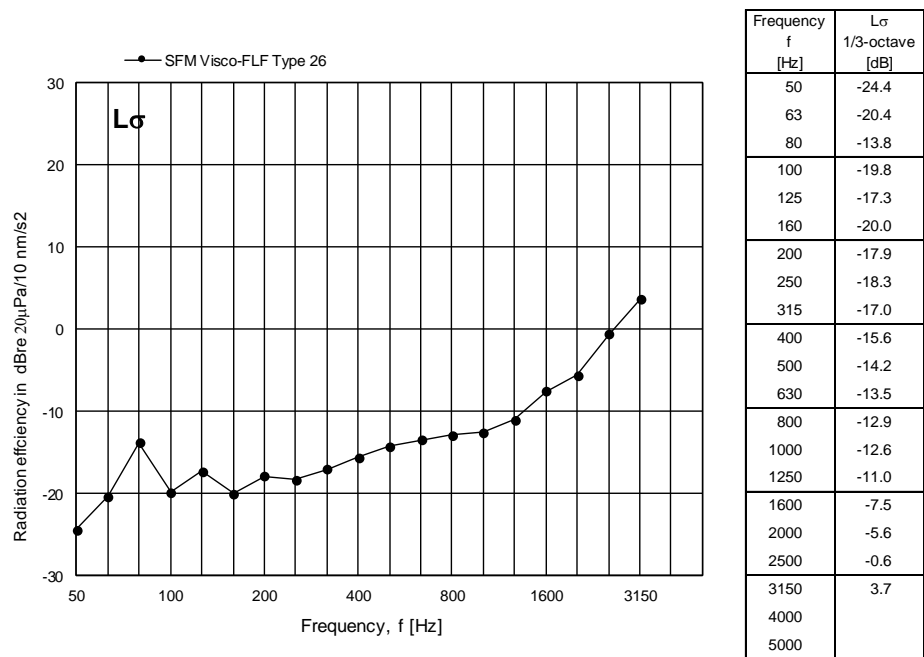
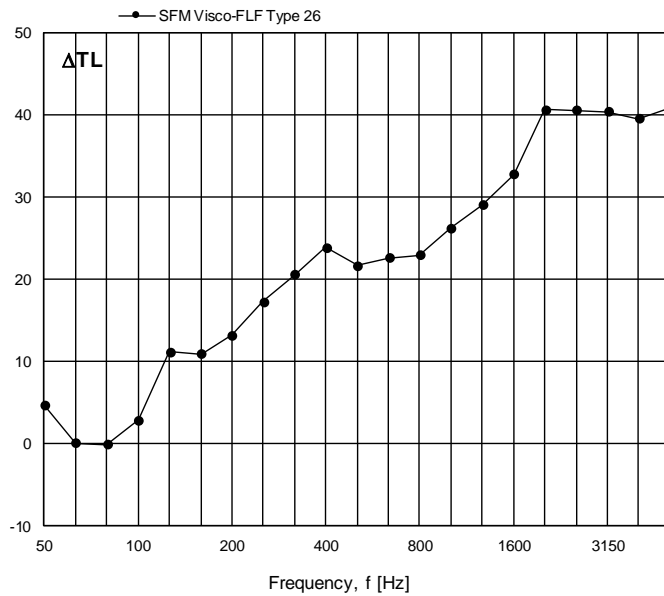

Figure 12
 Measured radiation index L_{σ} for Sikafloor® Marine Visco FLF Type 26 expressed in dB per one-third octave frequency band.

5.3.1 Effectiveness



Frequency f [Hz]	ΔTL dB
50	4.7
63	0.0
80	-0.2
100	2.8
125	11.1
160	10.9
200	13.1
250	17.2
315	20.5
400	23.9
500	21.6
630	22.5
800	22.9
1000	26.2
1250	29.0
1600	32.7
2000	40.6
2500	40.5
3150	40.3
4000	39.5
5000	40.8

Figure 13

Measured changes in transmission loss TL for Sikafloor® Marine Visco FLF Type 26 expressed in dB per one-third octave frequency band.

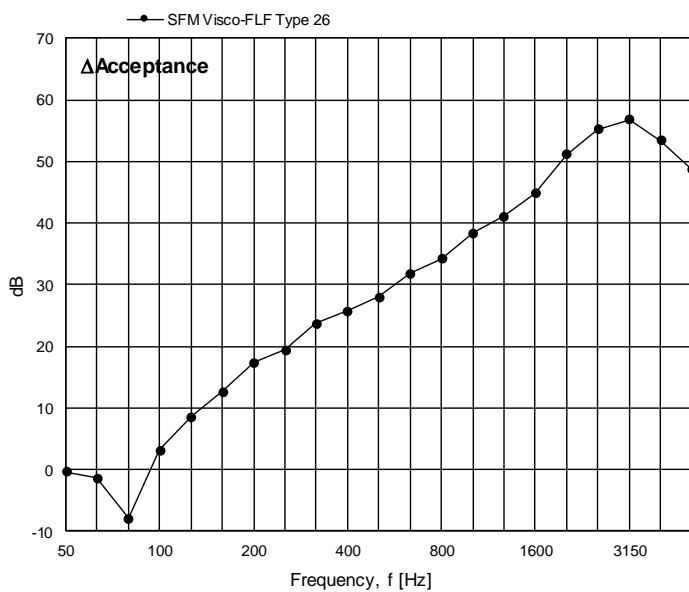

Frequency f [Hz]	dB
50	-0.4
63	-1.3
80	-8.0
100	3.2
125	8.5
160	12.6
200	17.4
250	19.4
315	23.7
400	25.7
500	28.0
630	31.8
800	34.2
1000	38.4
1250	41.1
1600	44.8
2000	51.2
2500	55.3
3150	56.8
4000	53.4
5000	48.7

Figure 14

Measured change in acceptance for Sikafloor® Marine Visco FLF Type 26 expressed in dB per one-third octave frequency band.

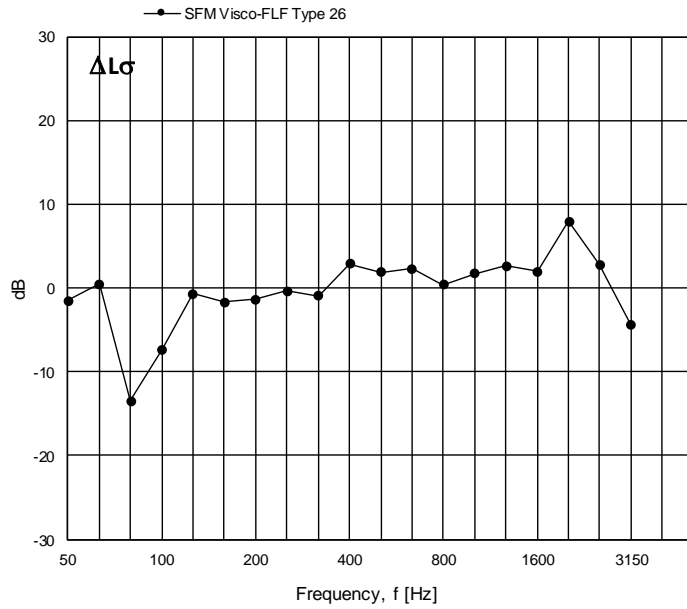

Frequency f [Hz]	dB
50	-1.5
63	0.5
80	-13.5
100	-7.4
125	-0.7
160	-1.7
200	-1.4
250	-0.4
315	-1.0
400	2.9
500	1.9
630	2.3
800	0.4
1000	1.7
1250	2.7
1600	2.0
2000	8.0
2500	2.8
3150	-4.5
4000	
5000	

Figure 15
 Measured change in radiation efficiency for Sikafloor® Marine Visco FLF Type 26 expressed in dB per one-third octave frequency band.

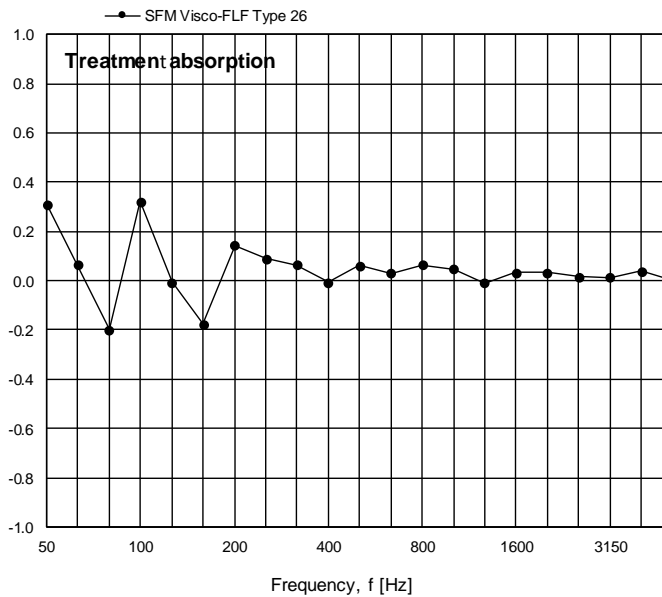

Frequency f [Hz]	α
50	0.31
63	0.06
80	-0.20
100	0.32
125	-0.01
160	-0.18
200	0.14
250	0.09
315	0.06
400	-0.01
500	0.06
630	0.03
800	0.06
1000	0.05
1250	-0.01
1600	0.03
2000	0.03
2500	0.02
3150	0.01
4000	0.04
5000	0.00

Figure 16
 Measured treatment absorption for Sikafloor® Marine Visco FLF Type 26 per one-third octave frequency band.

6. Comments

The measured insertion loss for vibration and sound pressure will in practice be better than measured in the laboratory due to the limited size of test deck. The results are in some degree influenced by the short distance to the excitation area of the deck.

The structure-borne radiated noise from the test object is influenced by background noise for frequencies above 3150 Hz.

7. References

- [1] ISO 10140:2015: “Acoustics – Laboratory measurement of sound insulation of building elements” -- Part 1.
- [2] ISO 10140:2010: “Acoustics – Laboratory measurement of sound insulation of building elements” -- Part 2, 3 and 5.
- [3] ISO 717:2013: “Acoustics – Rating of sound insulation in buildings and of building elements” -- Part 1 and 2.
- [4] “Procedure for measurement of acoustical and structural properties of marine flooring systems”, DELTA Technical Note, TC-100853.
- [5] ASTM E2963-16: “Standard Test Method for Laboratory Measurement of Acoustical Effectiveness of Ship Noise Treatments – Laboratory Measurement of Acoustical Effectiveness for Marine Bulkhead and Deck Treatments”.
- [6] ASTM E756-5(2010): “Standard Test Method for Measuring Vibration-Damping Properties of Materials”.
- [7] ASTM E90-09: “Standard Test Method for Laboratory Measurement of Airborne Sound Transmission Loss of Building Partitions and Elements”.
- [8] ASTM E413-10: “Classification for Rating Sound Insulation”.
- [9] ISO 10848-1:2006: “Acoustics -- Laboratory measurement of the flanking transmission of airborne and impact sound between adjoining rooms” -- Part 1: Frame document.
- [10] ISO 3382: “Measurement of the reverberation time of rooms with reference to other acoustical parameters”.

8. Instrumentation

Instrument	Type	DELTA No.	Calibration		
			Latest	Inter-mediate	Next
Real-Time Frequency Analyser	B&K 2270	1498L	July 2017	-	July 2019
Measuring Microphone	Gras 40 EN	1616L	Sep. 2016	-	Sep. 2018
Measuring Microphone	B&K 4165	006S	Sep 2017	-	May 2016
Microphone Preamplifier	B&K 2619	0707	Sep. 2017	-	Sep. 2018
Microphone Preamplifier	B&K 2619	815L	Jan. 2018	-	Jan. 2020
Microphone Power Supply	B&K 5935	1040L	Dec. 2016	-	Dec. 2018
Microphone Power Supply	B&K 5935	1392L	Dec 2016	-	Dec. 2018
Sound Level Calibrator	B&K 4231	1158L	April 2018	-	April 2019
Sensor for Temperature and Humidity	EBI-20- TH1	1216L	Feb. 2018	-	-
Exiter system	Ling 406	-	-	-	-
Force transducer (monitoring only)	B&K 8200	1149733	-	-	-
Accelerometer	IMI 608/A11	1501L	March 2016	-	March 2020
Accelerometer	IMI 608/A11	1502L	March 2016	-	March 2020
Accelerometer	IMI 608/A11	1503L	March 2016	-	March 2020
Accelerometer	IMI 608/A11	1504L	March 2016	-	March 2020
Accelerometer	IMI 608/A11	1613L	-	-	-
Accelerometer	IMI 608/A11	1614L	-	-	-
Charge Amplifier	B&K 2635	0496T	Jan. 2016	Jan. 2016	Jan. 2019
Accelerometer	B&K 4381	1587L	March 2015	-	March 2019
Accelerometer	B&K 4381	1588L	March 2015	-	March 2019
Vibration Calibrator	B&K 4294	1414L	Oct. 2015	Oct. 2015	Oct. 2018
Data acquisition	NI USB 9162	CTH2	May 2016	-	May 2018
Tapping Machine	B&K 3207	1250 L	-	-	-
Data acquisition 8 channel	NI	1333L	April 2016	-	April 2018
Data acquisition and data analysis software Noise Lab Capture 4.0	DELTA	-	-	-	-
Acoustical software Dirac	B&K	-	-	-	-
Acoustical software Reverb.08	DELTA	-	-	-	-

Table 2
Instruments used for the tests.

Graph Sheets 1-8



Laboratory measurement of sound reduction Index according to EN ISO 10140:2010

Customer: Sika Services AG
 Date of test: 12 march 2018
 Description of Test Specimen: SFM Visco-FLF Type 26
 Test specimen mounted by: The Client
 Place of measurement: Danish Technical University, Lyngby, Denmark

Test Areas, S: 10.0 m²
 Mass pr unit area: 58.2 kg/m²
 Temperature of air 004: 16.1 °C
 Humidity of Air 004: 42 % RH
 Temperature of air 904: 14.7 °C
 Humidity of Air 904: 49 % RH
 Source Room Volumen: 243 m³
 Receiving Room Volumen: 230 m³

Frequency f [Hz]	R' 1/3-octave [dB]
50	28.0
63	22.4
80	23.3
100	31.6
125	41.6
160	41.9
200	45.4
250	49.5
315	53.1
400	54.7
500	54.9
630	56.6
800	59.1
1000	63.8
1250	66.1
1600	66.3
2000	67.9
2500	69.4
3150	72.2
4000	74.8
5000	78.1

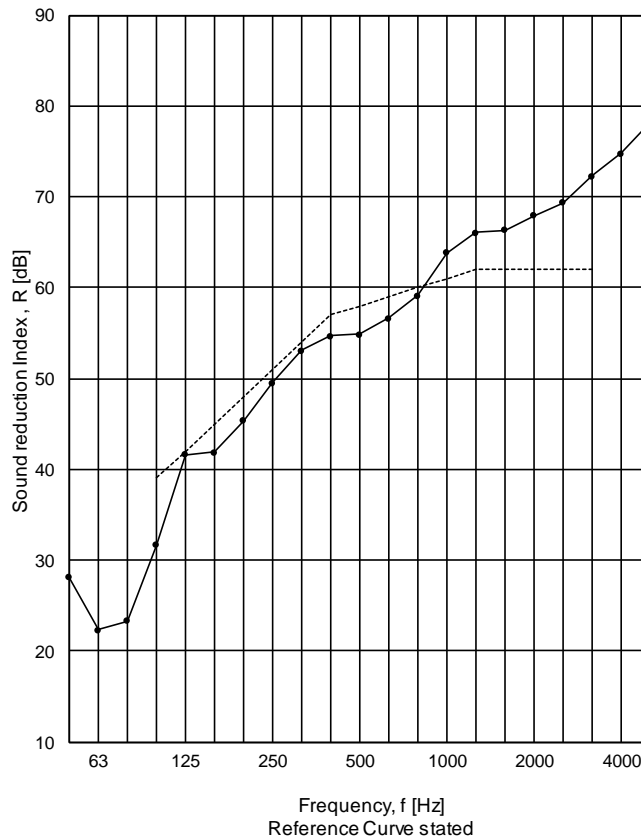

Weighted sound reduction index according to EN ISO 717-1:2013:

$$R'_w = 58 \text{ dB}$$

Evaluation based on laboratory measurement results obtained by an engineering method EN ISO 10140: part 1 (2015), and part 2, 3 and 5 (2010)

DELTA, 17 april 2018

Leif Ødegaard, DELTA Acoustics



Laboratory measurement of normalized impact sound pressure level according to EN ISO 10140:2010

Customer: Sika Services AG
 Date of test: 12 march 2018
 Description of Test Specimen: SFM Visco-FLF Type 26
 Test specimen mounted by: The Client
 Place of measurement: Danish Technical University, Lyngby, Denmark

Test Areas, S: 10.0 m²
 Mass pr unit area: 58.2 kg/m²
 Temperature of air 004: 16.1 °C
 Humidity of Air 004: 42 % RH
 Temperature of air 904: 14.7 °C
 Humidity of Air 904: 49 % RH
 Source Room Volumen: 243 m³
 Receiving Room Volumen: 230 m³

Frequency f [Hz]	L 1/3-octave [dB]
50	58.6
63	68.5
80	68.3
100	62.4
125	62.0
160	64.0
200	66.1
250	65.5
315	63.2
400	61.4
500	57.7
630	55.5
800	51.7
1000	46.2
1250	42.7
1600	40.7
2000	37.2
2500	31.1
3150	23.3
4000	16.8
5000	8.1



Weighted normalized impact sound pressure level according to EN ISO 717-2:2013:

$L_{n,w} = 58$ dB Calculated Impact Insulation Class IIC according to E989 ASTM : 53 dB

Evaluation based on laboratory measurement results obtained by an engineering method EN ISO 10140:part 1 (2015), and part 3, 4 and 5 (2010)

DELTA, 17 april 2018

Leif Ødegaard, DELTA Acoustics



Laboratory measurement of airborne sound transmission loss according to ASTM E2963-16

Customer: Sika Services AG
 Date of test: 12 march 2018
 Description of Test Specimen: SFM Visco-FLF Type 26
 Test specimen mounted by: The Client
 Place of measurement: Danish Technical University, Lyngby, Denmark

Test Areas, S: 10.0 m²
 Mass pr unit area: 58.2 kg/m²
 Temperature of air 004: 16.1 °C
 Humidity of Air 004: 42 % RH
 Temperature of air 904: 14.7 °C
 Humidity of Air 904: 49 % RH
 Source Room Volumen: 243 m³
 Receiving Room Volumen: 230 m³

Frequency f [Hz]	TL 1/3-octave [dB]
50	27.8
63	20.9
80	24.5
100	32.6
125	41.3
160	42.9
200	45.3
250	49.4
315	53.4
400	54.8
500	55.0
630	56.8
800	59.5
1000	64.2
1250	66.5
1600	66.8
2000	68.4
2500	69.9
3150	73.2
4000	76.0
5000	79.6

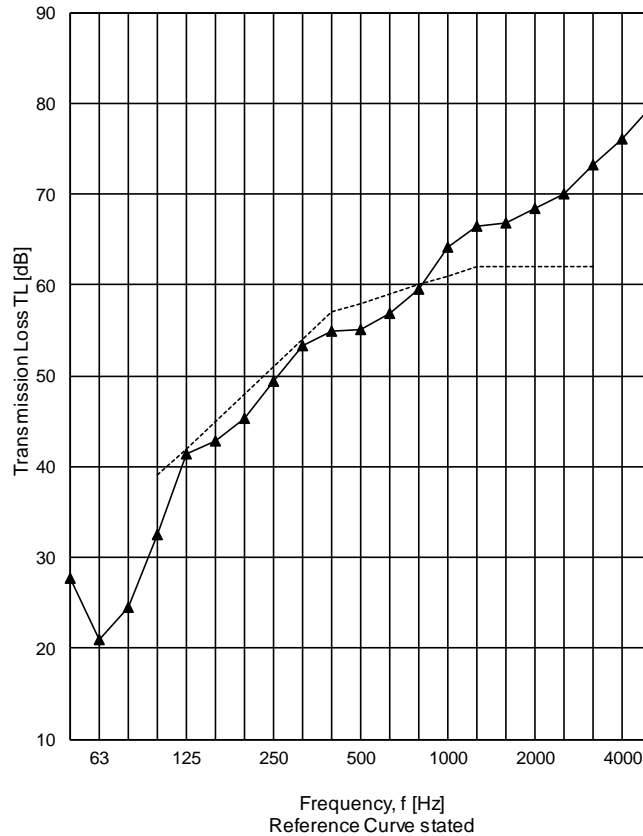

Weighted Sound Transmission Class according to ASTM E413 - 10 Classification for Rating Sound Insulation

STC = 59 dB

Evaluation based on laboratory measurement results obtained by an engineering method

DELTA, 17 april 2018

Leif Ødegaard, DELTA Acoustics



Laboratory measurement of radiation efficiency according to ASTM E2963-16

Customer: Sika Services AG
 Date of test: 12 march 2018
 Description of Test Specimen: SFM Visco-FLF Type 26
 Test specimen mounted by: The Client
 Place of measurement: Danish Technical University, Lyngby, Denmark

Test Areas, S: 10.0 m²
 Mass pr unit area: 58.2 kg/m²
 Temperature of air 004: 16.1 °C
 Humidity of Air 004: 42 % RH
 Temperature of air 904: 14.7 °C
 Humidity of Air 904: 49 % RH
 Source Room Volumen: 243 m³
 Receiving Room Volumen: 230 m³

Frequency f [Hz]	L _σ 1/3-octave [dB]
50	-24.4
63	-20.4
80	-13.8
100	-19.8
125	-17.3
160	-20.0
200	-17.9
250	-18.3
315	-17.0
400	-15.6
500	-14.2
630	-13.5
800	-12.9
1000	-12.6
1250	-11.0
1600	-7.5
2000	-5.6
2500	-0.6
3150	3.7
4000	
5000	

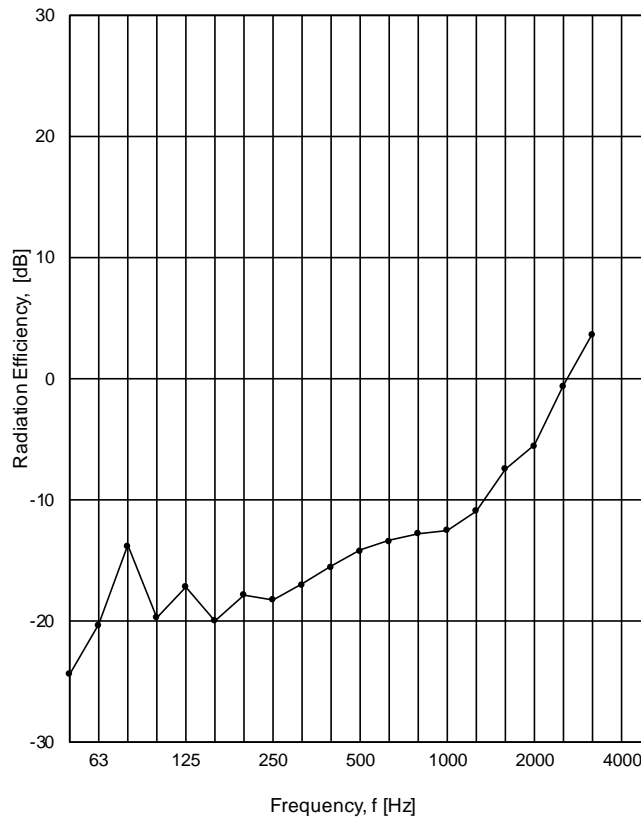

Evaluation based on laboratory measurement results obtained by an engineering method

DELTA, 17 april 2018

 Leif Ødegaard, DELTA Acoustics



Laboratory measurement of acceptance according to ASTM E2963-16

Customer: Sika Services AG
 Date of test: 12 march 2018
 Description of Test Specimen: SFM Visco-FLF Type 26
 Test specimen mounted by: The Client
 Place of measurement: Danish Technical University, Lyngby, Denmark

Test Areas, S: 10.0 m²
 Mass pr unit area: 58.2 kg/m²
 Temperature of air 004: 16.1 °C
 Humidity of Air 004: 42 % RH
 Temperature of air 904: 14.7 °C
 Humidity of Air 904: 49 % RH
 Source Room Volumen: 243 m³
 Receiving Room Volumen: 230 m³

Frequency f [Hz]	L _A 1/3-octave [dB]
50	6.3
63	9.8
80	7.3
100	20.3
125	24.5
160	27.1
200	29.2
250	32.3
315	37.0
400	39.6
500	44.5
630	50.2
800	55.5
1000	61.9
1250	66.4
1600	70.3
2000	76.1
2500	81.6
3150	84.3
4000	
5000	

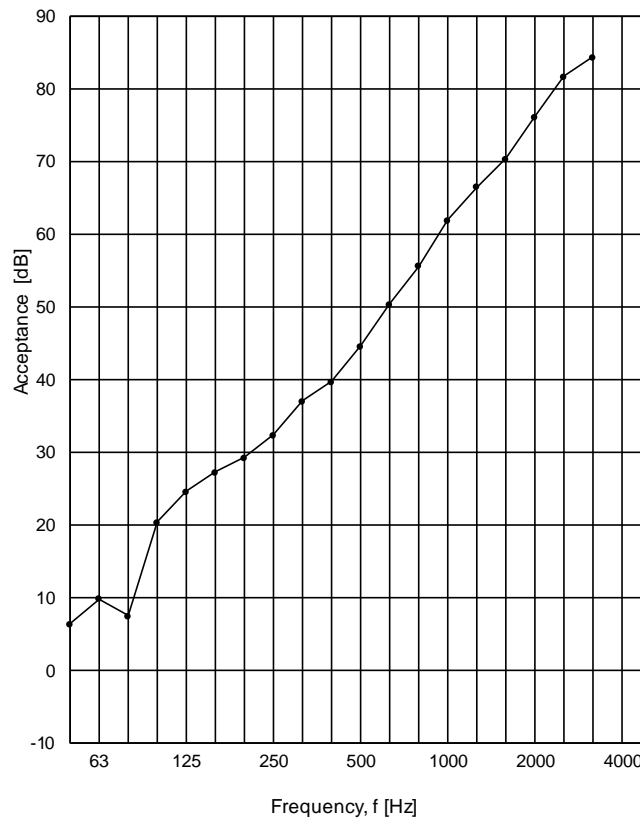

Evaluation based on laboratory measurement results obtained by an engineering method

DELTA, 17 april 2018

 Leif Ødegaard, DELTA Acoustics



Laboratory measurement of airborne sound transmission loss according to ASTM E2963-16

Customer: Sika Services AG
 Date of test: 19 February 2018
 Description of Test Specimen: 6 mm Reference Deck
 Test specimen mounted by: The Client
 Place of measurement: Danish Technical University, Lyngby, Denmark

Test Areas, S: 10.0 m²
 Mass pr unit area: 45.0 kg/m²
 Temperature of air 004: 16.1 °C
 Humidity of Air 004: 42 % RH
 Temperature of air 904: 14.8 °C
 Humidity of Air 904: 43 % RH
 Source Room Volumen: 243 m³
 Receiving Room Volumen: 230 m³

Frequency f [Hz]	TL 1/3-octave [dB]
50	23.1
63	20.9
80	24.7
100	29.8
125	30.3
160	32.0
200	32.2
250	32.2
315	32.8
400	31.0
500	33.4
630	34.3
800	36.6
1000	38.0
1250	37.4
1600	34.1
2000	27.8
2500	29.4
3150	32.9
4000	36.5
5000	38.7

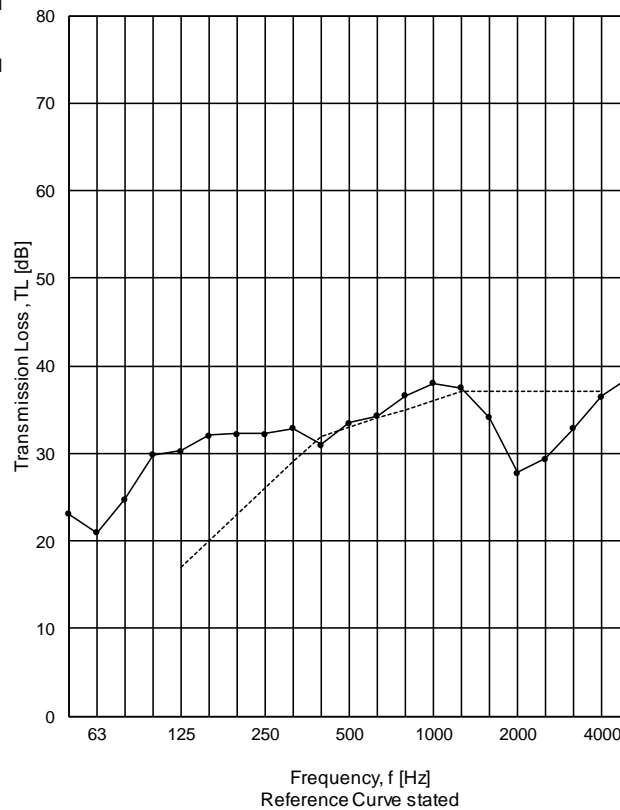

Weighted Sound Transmission Class according to ASTM E413 - 10 Classification for Rating Sound Insulation
STC = 33 dB
 Evaluation based on laboratory measurement results obtained by an engineering method

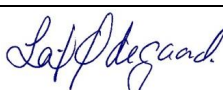
DELTA, 7 april 2018

 Leif Ødegaard, DELTA Acoustics



Laboratory measurement of radiation efficiency according to ASTM E2963-16

Customer: Sika Services AG
 Date of test: 19 February 2018
 Description of Test Specimen: 6 mm Reference Deck
 Test specimen mounted by: The Client
 Place of measurement: Danish Technical University, Lyngby, Denmark

Test Areas, S: 10.0 m²
 Mass pr unit area: 45.0 kg/m²
 Temperature of air 004: 16.1 °C
 Humidity of Air 004: 42 % RH
 Temperature of air 904: 14.8 °C
 Humidity of Air 904: 43 % RH
 Source Room Volumen: 243 m³
 Receiving Room Volumen: 230 m³

Frequency f [Hz]	L _σ 1/3-octave [dB]
50	-26.0
63	-19.9
80	-27.3
100	-27.1
125	-17.9
160	-21.7
200	-19.3
250	-18.7
315	-18.0
400	-12.7
500	-12.3
630	-11.1
800	-12.5
1000	-10.8
1250	-8.3
1600	-5.5
2000	2.4
2500	2.2
3150	-0.8
4000	-1.6
5000	-0.9

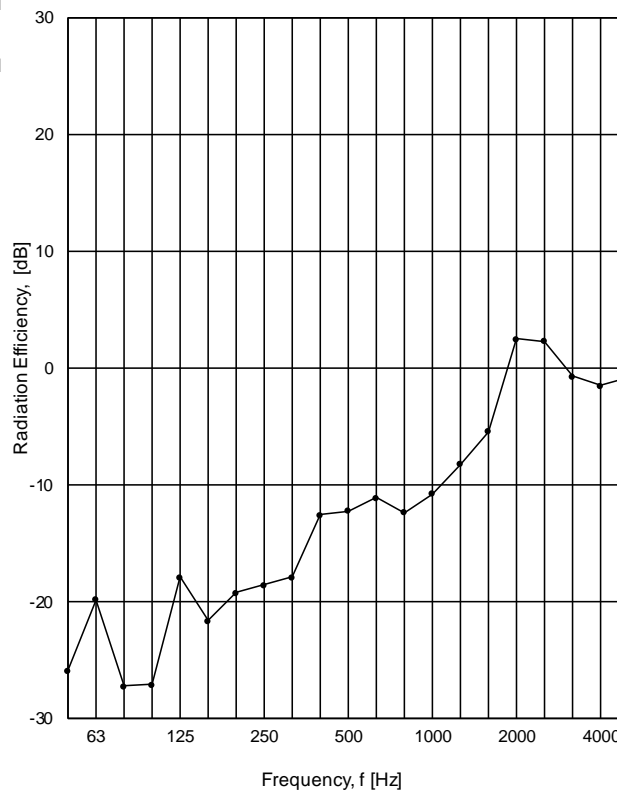

Evaluation based on laboratory measurement results obtained by an engineering method

DELTA, 7 april 2018

 Leif Ødegaard, DELTA Acoustics



Laboratory measurement of acceptance according to ASTM E2963-16

Customer: Sika Services AG
 Date of test: 19 February 2018
 Description of Test Specimen: 6 mm Reference Deck
 Test specimen mounted by: The Client
 Place of measurement: Danish Technical University, Lyngby, Denmark

Test Areas, S: 10.0 m²
 Mass pr unit area: 45.0 kg/m²
 Temperature of air 004: 16.1 °C
 Humidity of Air 004: 42 % RH
 Temperature of air 904: 14.8 °C
 Humidity of Air 904: 43 % RH
 Source Room Volumen: 243 m³
 Receiving Room Volumen: 230 m³

Frequency f [Hz]	L _A 1/3-octave [dB]
50	6.7
63	11.1
80	15.3
100	17.1
125	16.0
160	14.5
200	11.8
250	12.9
315	13.3
400	13.9
500	16.6
630	18.4
800	21.3
1000	23.5
1250	25.3
1600	25.5
2000	24.8
2500	26.4
3150	27.5
4000	29.9
5000	32.2

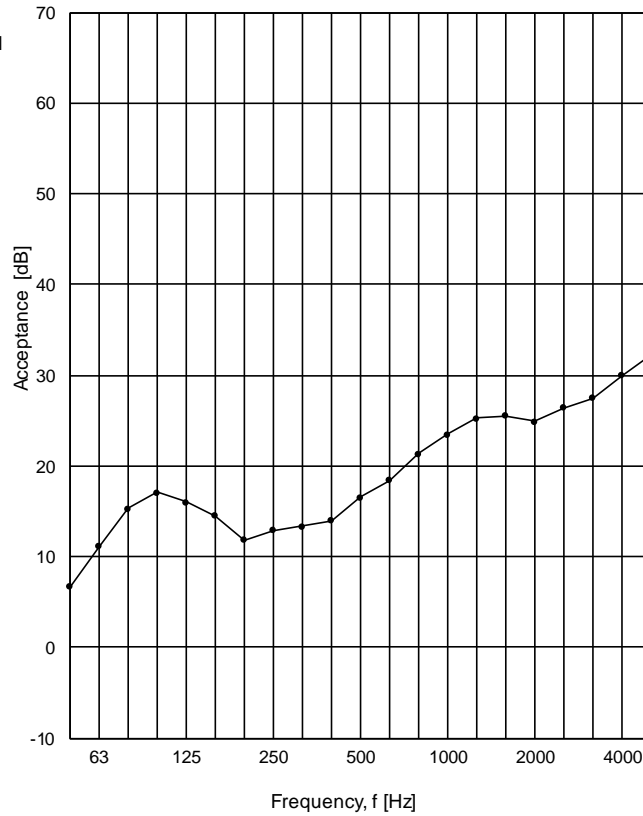

Evaluation based on laboratory measurement results obtained by an engineering method

DELTA, 7 april 2018

 Leif Ødegaard, DELTA Acoustics

SIKA WORLDWIDE



FOR MORE MARINE INFORMATION:



www.sika.com/marine

WHO WE ARE

Sika is a specialty chemicals company with a leading position in the development and production of systems and products for bonding, sealing, damping, reinforcing and protecting in the building sector and the motor vehicle industry. Sika has subsidiaries in 90 countries around the world and manufactures in over 160 factories. Its more than 17,000 employees generated annual sales of CHF 5,6 billion in 2014.

Our most current General Sales Conditions shall apply.
Please consult the Data Sheet prior to any use and processing.



SIKA SERVICES AG

Tueffenwies 16
8048 Zurich
Switzerland

CONTACT

Phone: +41 58 436 40 40
Fax: +41 58 436 55 30
www.sika.com/marine

BUILDING TRUST

